

CIGWELD

AN ESAB BRAND

STICK

TIG



Art # A-12966

WeldSkill 200HF

OPERATING MANUAL



200HF Inverter

Version No: AA | Issue Date: October, 2015 | Manual No: 0-5406



<http://warranties.cigweld.com.au>

Check out our online registration for the most up to date competitions and promotions



PROTECT YOUR INVESTMENT

Please register your warranty online immediately after purchase for complete warranty coverage and to guarantee your proof of purchase.



WE APPRECIATE YOUR BUSINESS!

Congratulations on your new CIGWELD product. We are proud to have you as our customer and will strive to provide you with the best service and reliability in the industry. This product is backed by our extensive warranty and world-wide service network. To locate your nearest distributor or accredited service provider call Australia: 1300 654 674, International Customers: +61 3 9474 7508, or visit us on the web at www.cigweld.com.au

This Operating Manual has been designed to instruct you on the correct use and operation of your CIGWELD product. Your satisfaction with this product and its safe operation is our ultimate concern. Therefore please take the time to read the entire manual, especially the Safety Precautions. They will help you to avoid potential hazards that may exist when working with this product.

We have made every effort to provide you with accurate instructions, drawings, and photographs of the product(s) while writing this manual. However errors do occur and we apologize if there are any contained in this manual.

Due to our constant effort to bring you the best products, we may make an improvement that does not get reflected in the manual. If you are ever in doubt about what you see or read in this manual with the product you received, then check for a newer version of the manual on our website or contact our customer support for assistance.

YOU ARE IN GOOD COMPANY!

The Brand of Choice for Contractors and Fabricators Worldwide.

CIGWELD is a Market Leading Brand of Arc Welding Products for ESAB. We are a mainline supplier to major welding industry sectors in the Asia Pacific and emerging global markets including; Manufacturing, Construction, Mining, Automotive, Engineering, Rural and DIY.

We distinguish ourselves from our competition through market-leading, dependable products that have stood the test of time. We pride ourselves on technical innovation, competitive prices, excellent delivery, superior customer service and technical support, together with excellence in sales and marketing expertise.

Above all, we are committed to develop technologically advanced products to achieve a safer working environment for industry operators.



WARNINGS

Read and understand this entire Manual and your employer's safety practices before installing, operating, or servicing the equipment.

While the information contained in this Manual represents the Manufacturer's best judgement, the Manufacturer assumes no liability for its use.

CIGWELD WeldSkill 200HF Welding Inverter
Instruction Manual Number 0-5406 for:
Part Number W1008200

Published by:
CIGWELD Pty Ltd
CIGWELD An ESAB Brand
71 Gower Street,
Preston, Victoria, Australia, 3072
Tel: +61 3 9474 7400 Fax: +61 3 9474 7391

www.cigweld.com.au

Copyright 2015
CIGWELD Pty Ltd

All rights reserved.

Reproduction of this work, in whole or in part, without written permission of the publisher is prohibited.

The publisher does not assume and hereby disclaims any liability to any party for any loss or damage caused by any error or omission in this Manual, whether such error results from negligence, accident, or any other cause.

For Printing Material Specification refer to document 47x1915.

Publication Date: October, 2015

Record the following information for Warranty purposes:

Where Purchased: _____

Purchase Date: _____

Equipment Serial #: _____

TABLE OF CONTENTS

| | | |
|-------------------|---|------------|
| SECTION 1: | | |
| | ARC WELDING SAFETY INSTRUCTIONS AND WARNINGS | 1-1 |
| 1.01 | Arc Welding Hazards..... | 1-1 |
| 1.02 | PRINCIPAL SAFETY STANDARDS..... | 1-5 |
| 1.03 | DECLARATION OF CONFORMITY..... | 1-6 |
| SECTION 2: | | |
| | INTRODUCTION | 2-1 |
| 2.01 | How To Use This Manual | 2-1 |
| 2.02 | Equipment Identification | 2-1 |
| 2.03 | Receipt Of Equipment | 2-1 |
| 2.04 | Symbol Chart..... | 2-2 |
| 2.05 | Description | 2-3 |
| 2.06 | User Responsibility..... | 2-3 |
| 2.07 | Packaged Item | 2-3 |
| 2.08 | Transporting Methods..... | 2-4 |
| 2.09 | Duty Cycle..... | 2-4 |
| 2.10 | Specifications | 2-4 |
| 2.11 | Optional Accessories | 2-5 |
| 2.11 | Optional Accessories (Cont'd) | 2-6 |
| SECTION 3: | | |
| | INSTALLATION | 3-1 |
| 3.01 | Environment | 3-1 |
| 3.02 | Location..... | 3-1 |
| 3.03 | Ventilation..... | 3-1 |
| 3.04 | Mains Supply Voltage Requirements | 3-1 |
| 3.05 | Generators..... | 3-1 |
| 3.06 | Electromagnetic Compatibility | 3-2 |
| SECTION 4: | | |
| | OPERATION | 4-1 |
| 4.01 | Overview..... | 4-1 |
| 4.02 | Power Source Controls, Indicators and Features | 4-1 |
| SECTION 5: | | |
| | TIG (GTAW) WELDING..... | 5-1 |
| 5.01 | Shielding Gas Regulator/Flowmeter Operating Instructions..... | 5-1 |
| 5.02 | Setup For TIG (GTAW) Welding | 5-4 |
| 5.03 | TIG (GTAW) Basic Welding Technique | 5-6 |
| 5.04 | TIG (GTAW) Welding Problems..... | 5-8 |
| SECTION 6: | | |
| | STICK (MMAW) WELDING | 6-1 |
| 6.01 | Setup For STICK (MMAW) Welding | 6-1 |
| 6.02 | Arc Welding Electrodes..... | 6-2 |
| 6.03 | Types of Electrodes..... | 6-2 |
| 6.04 | Size of Electrode | 6-3 |
| 6.05 | Storage of Electrodes..... | 6-3 |
| 6.06 | Electrode Polarity..... | 6-3 |
| 6.07 | Effects of Arc Welding Various Materials | 6-4 |
| 6.08 | Arc Welding Practice..... | 6-4 |
| 6.09 | Welding Position..... | 6-4 |

TABLE OF CONTENTS

| | | |
|------|-------------------------------------|------|
| 6.10 | Joint Preparations..... | 6-5 |
| 6.11 | Arc Welding Technique | 6-6 |
| 6.12 | The Welder..... | 6-6 |
| 6.13 | Striking the Arc | 6-6 |
| 6.14 | Arc Length | 6-6 |
| 6.15 | Rate of Travel..... | 6-6 |
| 6.16 | Making Welded Joints..... | 6-6 |
| 6.17 | Distortion..... | 6-9 |
| 6.18 | The Cause of Distortion | 6-9 |
| 6.19 | Overcoming Distortion Effects | 6-9 |
| 6.20 | Welding Problems | 6-11 |

SECTION 7:

ROUTINE SERVICE REQUIREMENTS AND POWER SOURCE PROBLEMS 7-1

| | | |
|------|---|-----|
| 7.01 | Routine Maintenance & Inspection | 7-1 |
| 7.02 | Cleaning the Welding Power Source | 7-1 |
| 7.03 | Basic Troubleshooting | 7-1 |
| 7.04 | Power Source Problems | 7-2 |

SECTION 8: KEY SPARE PARTS 8-1

| | | |
|------|---------------------------------------|-----|
| 8.01 | WeldSkill 200HF Key Spare Parts | 8-1 |
|------|---------------------------------------|-----|

CIGWELD - LIMITED WARRANTY TERMS

WARRANTY SCHEDULE – WELDSKILL 200HF INVERTER

SECTION 1: ARC WELDING SAFETY INSTRUCTIONS AND WARNINGS



WARNING

PROTECT YOURSELF AND OTHERS FROM POSSIBLE SERIOUS INJURY OR DEATH. KEEP CHILDREN AWAY. PACEMAKER WEARERS KEEP AWAY UNTIL CONSULTING YOUR DOCTOR. DO NOT LOSE THESE INSTRUCTIONS. READ OPERATING/INSTRUCTION MANUAL BEFORE INSTALLING, OPERATING OR SERVICING THIS EQUIPMENT.

Welding products and welding processes can cause serious injury or death, or damage to other equipment or property, if the operator does not strictly observe all safety rules and take precautionary actions.

Safe practices have developed from past experience in the use of welding and cutting. These practices must be learned through study and training before using this equipment. Some of these practices apply to equipment connected to power lines; other practices apply to engine driven equipment. Anyone not having extensive training in welding and cutting practices should not attempt to weld.

Safe practices are outlined in the Australian Standard AS1674.2-2007 entitled: Safety in welding and allied processes Part 2: Electrical. This publication and other guides to what you should learn before operating this equipment are listed at the end of these safety precautions. **HAVE ALL INSTALLATION, OPERATION, MAINTENANCE, AND REPAIR WORK PERFORMED ONLY BY QUALIFIED PEOPLE.**

1.01 Arc Welding Hazards



WARNING

ELECTRIC SHOCK can kill.

Touching live electrical parts can cause fatal shocks or severe burns. The electrode and work circuit is electrically live whenever the output is on. The input power circuit and machine internal circuits are also live when power is on. In semiautomatic or automatic wire welding, the wire, wire reel, drive roll housing, and all metal parts touching the welding wire are electrically live. Incorrectly installed or improperly grounded equipment is a hazard.

1. Do not touch live electrical parts.
2. Wear dry, hole-free insulating gloves and body protection.
3. Insulate yourself from work and ground using dry insulating mats or covers.
4. Disconnect input power or stop engine before installing or servicing this equipment. Lock input power disconnect switch open, or remove line fuses so power cannot be turned on accidentally.
5. Properly install and ground this equipment according to its Owner's Manual and national, state, and local codes.
6. Turn off all equipment when not in use. Disconnect power to equipment if it will be left unattended or out of service.
7. Use fully insulated electrode holders. Never dip holder in water to cool it or lay it down on the ground or the work surface. Do not touch holders connected to two welding machines at the same time or touch other people with the holder or electrode.
8. Do not use worn, damaged, undersized, or poorly spliced cables.
9. Do not wrap cables around your body.
10. Ground the workpiece to a good electrical (earth) ground.
11. Do not touch electrode while in contact with the work (ground) circuit.
12. Use only well-maintained equipment. Repair or replace damaged parts at once.
13. In confined spaces or damp locations, do not use a welder with AC output unless it is equipped with a voltage reducer. Use equipment with DC output.
14. Wear a safety harness to prevent falling if working above floor level.
15. Keep all panels and covers securely in place.

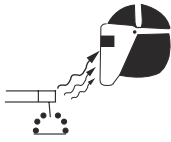

WARNING

ARC RAYS can burn eyes and skin; NOISE can damage hearing.

Arc rays from the welding process produce intense heat and strong ultraviolet rays that can burn eyes and skin. Noise from some processes can damage hearing.

1. Use a Welding Helmet or Welding Faceshield fitted with a proper shade of filter (see ANSI Z49.1 and AS 1674 listed in Safety Standards) to protect your face and eyes when welding or watching.
2. Wear approved safety glasses. Side shields recommended.
3. Use protective screens or barriers to protect others from flash and glare; warn others not to watch the arc.
4. Wear protective clothing made from durable, flame-resistant material (wool and leather) and foot protection.
5. Use approved ear plugs or ear muffs if noise level is high.
6. Never wear contact lenses while welding.

| Recommended Protective Filters for Electric Welding | | |
|---|--|-----------------------------------|
| Description of Process | Approximate Range of Welding Current in Amps | Minimum Shade Number of Filter(s) |
| Manual Metal Arc Welding - covered electrodes (MMAW) | Less than or equal to 100 | 8 |
| | 100 to 200 | 10 |
| | 200 to 300 | 11 |
| | 300 to 400 | 12 |
| | Greater than 400 | 13 |
| Gas Metal Arc Welding (GMAW) (MIG) other than Aluminium and Stainless Steel | Less than or equal to 150 | 10 |
| | 150 to 250 | 11 |
| | 250 to 300 | 12 |
| | 300 to 400 | 13 |
| | Greater than 400 | 14 |
| Gas Metal Arc Welding (GMAW) (MIG) Aluminium and Stainless Steel | Less than or equal to 250 | 12 |
| | 250 to 350 | 13 |
| Gas Tungsten Arc Welding (GTAW) (TIG) | Less than or equal to 100 | 10 |
| | 100 to 200 | 11 |
| | 200 to 250 | 12 |
| | 250 to 350 | 13 |
| | Greater than 350 | 14 |
| Flux-cored Arc Welding (FCAW) -with or without shielding gas. | Less than or equal to 300 | 11 |
| | 300 to 400 | 12 |
| | 400 to 500 | 13 |
| | Greater than 500 | 14 |
| Air - Arc Gouging | Less than or equal to 400 | 12 |
| Plasma - Arc Cutting | 50 to 100 | 10 |
| | 100 to 400 | 12 |
| | 400 to 800 | 14 |
| Plasma - Arc Spraying | — | 15 |
| Plasma - Arc Welding | Less than or equal to 20 | 8 |
| | 20 to 100 | 10 |
| | 100 to 400 | 12 |
| | 400 to 800 | 14 |
| Submerged - Arc Welding | — | 2(5) |
| Resistance Welding | — | Safety Spectacles or eye shield |

Refer to standard AS/NZS 1338.1:1992 for comprehensive information regarding the above table.

**WARNING**

FUMES AND GASES can be hazardous to your health.

Welding produces fumes and gases. Breathing these fumes and gases can be hazardous to your health.

1. Keep your head out of the fumes. Do not breathe the fumes.
2. If inside, ventilate the area and/or use exhaust at the arc to remove welding fumes and gases.
3. If ventilation is poor, use an approved air-supplied respirator.
4. Read the Material Safety Data Sheets (MSDSs) and the manufacturer's instruction for metals, consumables, coatings, and cleaners.
5. Work in a confined space only if it is well ventilated, or while wearing an air-supplied respirator. Shielding gases used for welding can displace air causing injury or death. Be sure the breathing air is safe.
6. Do not weld in locations near degreasing, cleaning, or spraying operations. The heat and rays of the arc can react with vapours to form highly toxic and irritating gases.
7. Do not weld on coated metals, such as galvanized, lead, or cadmium plated steel, unless the coating is removed from the weld area, the area is well ventilated, and if necessary, while wearing an air-supplied respirator. The coatings and any metals containing these elements can give off toxic fumes if welded.

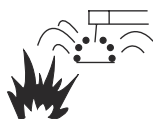
**WARNING**

WELDING can cause fire or explosion.

Sparks and spatter fly off from the welding arc. The flying sparks and hot metal, weld spatter, hot workpiece, and hot equipment can cause fires and burns. Accidental contact of electrode or welding wire to metal objects can cause sparks, overheating, or fire.

1. Protect yourself and others from flying sparks and hot metal.
2. Do not weld where flying sparks can strike flammable material.

3. Remove all flammables within 35 ft (10.7 m) of the welding arc. If this is not possible, tightly cover them with approved covers.
4. Be alert that welding sparks and hot materials from welding can easily go through small cracks and openings to adjacent areas.
5. Watch for fire, and keep a fire extinguisher nearby.
6. Be aware that welding on a ceiling, floor, bulkhead, or partition can cause fire on the hidden side.
7. Do not weld on closed containers such as tanks or drums.
8. Connect work cable to the work as close to the welding area as practical to prevent welding current from travelling long, possibly unknown paths and causing electric shock and fire hazards.
9. Do not use welder to thaw frozen pipes.
10. Remove stick electrode from holder or cut off welding wire at contact tip when not in use.

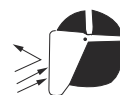
**WARNING**

FLYING SPARKS AND HOT METAL can cause injury.

Chipping and grinding cause flying metal. As welds cool, they can throw off slag.

1. Wear approved face shield or safety goggles. Side shields recommended.
2. Wear proper body protection to protect skin.

**WARNING**

CYLINDERS can explode if damaged.

Shielding gas cylinders contain gas under high pressure. If damaged, a cylinder can explode. Since gas cylinders are normally part of the welding process, be sure to treat them carefully.

1. Protect compressed gas cylinders from excessive heat, mechanical shocks, and arcs.
2. Install and secure cylinders in an upright position by chaining them to a stationary support or equipment cylinder rack to prevent falling or tipping.
3. Keep cylinders away from any welding or other electrical circuits.

4. Never allow a welding electrode to touch any cylinder.
5. Use only correct shielding gas cylinders, regulators, hoses, and fittings designed for the specific application; maintain them and associated parts in good condition.
6. Turn face away from valve outlet when opening cylinder valve.
7. Keep protective cap in place over valve except when cylinder is in use or connected for use.
8. Read and follow instructions on compressed gas cylinders, associated equipment, and CGA publication P-1 listed in Safety Standards.

**WARNING**

MOVING PARTS can cause injury.

Moving parts, such as fans, rotors, and belts can cut fingers and hands and catch loose clothing.

1. Keep all doors, panels, covers, and guards closed and securely in place.
2. Stop engine before installing or connecting unit.
3. Have only qualified people remove guards or covers for maintenance and troubleshooting as necessary.
4. To prevent accidental starting during servicing, disconnect negative (-) battery cable from battery.
5. Keep hands, hair, loose clothing, and tools away from moving parts.
6. Reinstall panels or guards and close doors when servicing is finished and before starting engine.

**WARNING**

This product, when used for welding or cutting, produces fumes or gases which contain chemicals known to the State of California to cause birth defects and, in some cases, cancer. (California Health & Safety code Sec. 25249.5 et seq.)

NOTE

Considerations About Welding And The Effects of Low Frequency Electric and Magnetic Fields

The following is a quotation from the General Conclusions Section of the U.S. Congress, Office of Technology Assessment, Biological Effects of Power

Frequency Electric & Magnetic Fields - Background Paper, OTA-BP-E-63 (Washington, DC: U.S. Government Printing Office, May 1989): "...there is now a very large volume of scientific findings based on experiments at the cellular level and from studies with animals and people which clearly establish that low frequency magnetic fields and interact with, and produce changes in, biological systems. While most of this work is of very high quality, the results are complex. Current scientific understanding does not yet allow us to interpret the evidence in a single coherent framework. Even more frustrating, it does not yet allow us to draw definite conclusions about questions of possible risk or to offer clear science-based advice on strategies to minimize or avoid potential risks."

To reduce magnetic fields in the workplace, use the following procedures.

1. Keep cables close together by twisting or taping them.
2. Arrange cables to one side and away from the operator.
3. Do not coil or drape cable around the body.
4. Keep welding power source and cables as far away from body as practical.

**ABOUT PACEMAKERS:**

The above procedures are among those also normally recommended for pacemaker wearers. Consult your doctor for complete information.

1.02 PRINCIPAL SAFETY STANDARDS

Safety in Welding and Cutting, ANSI Standard Z49.1, from American Welding Society, 550 N.W. LeJeune Rd., Miami, FL 33126.

Safety and Health Standards, OSHA 29 CFR 1910, from Superintendent of Documents, U.S. Government Printing Office, Washington, D.C. 20402.

Recommended Safe Practices for the Preparation for Welding and Cutting of Containers That Have Held Hazardous Substances, American Welding Society Standard AWS F4.1, from American Welding Society, 550 N.W. LeJeune Rd., Miami, FL 33126.

National Electrical Code, NFPA Standard 70, from National Fire Protection Association, Batterymarch Park, Quincy, MA 02269.

Safe Handling of Compressed Gases in Cylinders, CGA Pamphlet P-1, from Compressed Gas Association, 1235 Jefferson Davis Highway, Suite 501, Arlington, VA 22202.

Code for Safety in Welding and Cutting, CSA Standard W117.2, from Canadian Standards Association, Standards Sales, 178 Rexdale Boulevard, Rexdale, Ontario, Canada M9W 1R3.

Safe Practices for Occupation and Educational Eye and Face Protection, ANSI Standard Z87.1, from American National Standards Institute, 1430 Broadway, New York, NY 10018.

Cutting and Welding Processes, NFPA Standard 51B, from National Fire Protection Association, Batterymarch Park, Quincy, MA 02269.

Safety in welding and allied processes Part 1: Fire Precautions, AS 1674.1-1997 from SAI Global Limited, www.saiglobal.com.

Safety in welding and allied processes Part 2: Electrical, AS 1674.2-2007 from SAI Global Limited, www.saiglobal.com.

Filters for eye protectors - Filters for protection against radiation generated in welding and allied operations AS/NZS 1338.1:1992 from SAI Global Limited, www.saiglobal.com.

1.03 DECLARATION OF CONFORMITY

Manufacturer: CIGWELD
Address: 71 Gower St, Preston
Victoria 3072

Australia

Description of equipment: Welding Equipment (MMAW, GTAW) including, but not limited to CIGWELD WeldSkill 200HF inverter and associated accessories.

Serial numbers are unique with each individual piece of equipment and details description, parts used to manufacture a unit and date of manufacture.

The equipment conforms to all applicable aspects and regulations of the 'Low Voltage Directive' (Directive 2006/95/EC) and to the National legislation for the enforcement of the Directive.

National Standard and Technical Specifications

The product is designed and manufactured to a number of standards and technical requirements among them are:

- IEC 60974-10 applicable to Industrial Equipment - generic emissions and regulations.
- AS 60974.1 / IEC 60974-1 applicable to welding equipment and associated accessories.

Extensive product design verification is conducted at the manufacturing facility as part of the routine design and manufacturing process, to ensure the product is safe and performs as specified. Rigorous testing is incorporated into the manufacturing process to ensure the manufactured product meets or exceeds all design specifications.

CIGWELD has been manufacturing and merchandising an extensive equipment range with superior performance, ultra safe operation and world class quality for more than 30 years and will continue to achieve excellence.

SECTION 2: INTRODUCTION

2.01 How To Use This Manual

This Owners Manual only applies to the Part Numbers listed on page i.

To ensure safe operation, read the entire manual, including the chapter on safety instructions and warnings.

Throughout this manual, the words WARNING, CAUTION, and NOTE may appear. Pay particular attention to the information provided under these headings. These special annotations are easily recognized as follows:



WARNING

Gives information regarding possible personal injury. Warnings will be enclosed in a box such as this.



CAUTION

Refers to possible equipment damage. Cautions will be shown in bold type.

NOTE

Offers helpful information concerning certain operating procedures. Notes will be shown in italics.

Additional copies of this manual may be purchased by contacting CIGWELD at the address and phone number for your location listed in the inside back cover of this manual. Include the Owner's Manual number and equipment identification numbers.

Electronic copies of this manual can also be downloaded at no charge in Acrobat PDF format by going to the CIGWELD web site listed below and clicking on the Literature Library link:

<http://www.cigweld.com.au>

2.02 Equipment Identification

The unit's identification number (specification or part number), model, and serial number usually appear on a nameplate attached to the control panel. In some cases, the nameplate may be attached to the rear panel. Equipment which does not have a control panel such as gun and cable assemblies is identified only by the specification or part number printed on the shipping container. Record these numbers on the bottom of page i for future reference.

2.03 Receipt Of Equipment















When you receive the equipment, check it against the invoice to make sure it is complete and inspect the equipment for possible damage due to shipping. If there is any damage, notify the carrier immediately to file a claim. Furnish complete information concerning damage claims or shipping errors to the location in your area listed in the inside back cover of this manual.





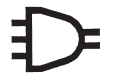











Include all equipment identification numbers as described above along with a full description of the parts in error.









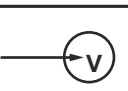

Move the equipment to the installation site before un-crating the unit. Use care to avoid damaging the equipment when using bars, hammers, etc., to un-crate the unit.

2.04 Symbol Chart

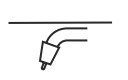
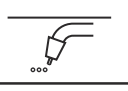
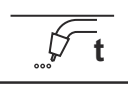
Note that only some of these symbols will appear on your model.

| | |
|---|---------------------------------------|
|  | On |
|  | Off |
|  | Dangerous Voltage |
|  | Increase/Decrease |
|  | Circuit Breaker |
|  | AC Auxiliary Power |
|  | Fuse |
| A | Amperage |
| V | Voltage |
| Hz | Hertz (cycles/sec) |
| f | Frequency |
|  | Negative |
|  | Positive |
|  | Direct Current (DC) |
|  | Protective Earth (Ground) |
|  | Line |
|  | Line Connection |
|  | Auxiliary Power |
| 115V 15A  | Receptacle Rating- Auxiliary Power |

| | |
|--|---|
| 1  | Single Phase |
| 3  | Three Phase |
|  | Three Phase Static Frequency Converter- Transformer-Rectifier |
|  | Remote |
| X | Duty Cycle |
| % | Percentage |
|  | Panel/Local |
|  | Shielded Metal Arc Welding (SMAW) |
|  | Gas Metal Arc Welding (GMAW) |
|  | Gas Tungsten Arc Welding (GTAW) |
|  | Air Carbon Arc Cutting (CAC-A) |
|  | Constant Current |
|  | Constant Voltage Or Constant Potential |
|  | High Temperature |
|  | Fault Indication |
|  | Arc Force |
|  | Touch Start (GTAW) |
|  | Variable Inductance |
|  | Voltage Input |

| | |
|--|--|
|  | Wire Feed Function |
|  | Wire Feed Towards Workpiece With Output Voltage Off. |
|  | Welding Gun |
|  | Purging Of Gas |
|  | Continuous Weld Mode |
|  | Spot Weld Mode |
|  | Spot Time |
|  | Preflow Time |
|  | Postflow Time |
|  | 2 Step Trigger Operation |
| Press to initiate wirefeed and welding, release to stop. | |
|  | 4 Step Trigger Operation |
| Press and hold for preflow, release to start arc. Press to stop arc, and hold for preflow. | |
|  | Burnback Time |
|  | Disturbance In Ground System |
| IPM | Inches Per Minute |
| MPM | Metres Per Minute |
| | |
| | |

Art # A-12893

2.05 Description

The WeldSkill 200HF is a single phase 15 Amp constant current welding inverter capable of performing 180 Amps in MMAW (Stick) with a maximum electrode size of 4.0mm and 200Amps in GTAW (non-contact start HF Tig and touch start Lift Tig).

This welding inverter has a user-friendly control panel with practical push button operation for mode selection, clearly visible LED indicators and sturdy large control knobs that are easy to grip and control even with your gloves on.

Weighing only 8.2kg and fitted with a convenient carry strap and robust handle means the 200HF can easily be thrown over your shoulder and carried up and down ladders or around awkward areas of the worksite, making it ideal for remote repair and maintenance jobs.

This compact, and light-weight unit is a great addition to the workshop ensuring the ultimate portability in light TIG fabrication and stainless steel work for the Tradesman or Maintenance Worker.

The WeldSkill 200HF is supplied standard with features such as Arc Force, Down Slope Control (2T & 4T), Hot Start, Post Gas Flow and Anti-Stick assisting you in controlling arc stability and achieving smoother welding results.

This affordable welding inverter package also comes with the added convenience of a Tig Torch with remote current control and a 4 metre twist lock electrode holder that provides excellent electrode grip and flexibility as you can weld up to 4m away from the unit.

In addition to its appealing design and functional features, the 200HF provides the added reassurance of a high quality welding inverter conforms with Australian Standard AS 60974.1 and IEC 60974.1 and is complimented with a 3 year warranty that has been tested through rigorous 40 °C temperature testing, drop testing, life cycle testing, and IP21S water ingress testing. Simply plug it into any standard 15 Amp power point and get welding right away!

2.06 User Responsibility

This equipment will perform as per the information contained herein when installed, operated, maintained and repaired in accordance with the instructions provided. This equipment must be checked periodically. Defective equipment (including welding leads) should not be used. Parts that are broken, missing, plainly worn, distorted or contaminated, should be replaced immediately. Should such repairs or replacements become necessary, it is recommended that such repairs be carried out by appropriately qualified persons approved by CIGWELD. Advice in this regard can be obtained by contacting accredited CIGWELD Distributor.

This equipment or any of its parts should not be altered from standard specification without prior written approval of CIGWELD. The user of this equipment shall have the sole responsibility for any malfunction which results from improper use or unauthorised modification from standard specification, faulty maintenance, damage or improper repair by anyone other than appropriately qualified persons approved by CIGWELD.

2.07 Packaged Item

WeldSkill 200HF Inverter (Part No. W1008200)

- WeldSkill 200HF Inverter Power Source
- TIG Torch type 26F with flex head, 4m lead, trigger switch and remote current control
- TIG Torch Accessory Kit that includes 1.6mm and 2.4mm tungstens with collets, collet bodies and No 4, 5 & 6 Alumina Nozzles
- WeldSkill Argon Regulator/Flowmeter
- 4m Lead with Twistlock Electrode Holder
- 4m Lead with Work Clamp
- Shielding Gas Hose Assembly
- Shoulder Strap
- Operating Manual

2.08 Transporting Methods

These units are equipped with a handle for carrying purposes.



WARNING

ELECTRIC SHOCK can kill. DO NOT TOUCH live electrical parts. Disconnect input power conductors from de-energized supply line before moving the welding power source.



WARNING

FALLING EQUIPMENT can cause serious personal injury and equipment damage.

Lift unit with handle on top of case.

Use handcart or similar device of adequate capacity.

If using a fork lift vehicle, place and secure unit on a proper skid before transporting.

2.09 Duty Cycle

The rated duty cycle of a Welding Power Source, is a statement of the time it may be operated at its rated welding current output without exceeding the temperature limits of the insulation of the component parts. To explain the 10 minute duty cycle period the following example is used. Suppose a Welding Power Source is designed to operate at a 15% duty cycle, 90 amperes at 23.6 volts. This means that it has been designed and built to provide the rated amperage (90A) for 1.5 minutes, i.e. arc welding time, out of every 10 minute period (15% of 10 minutes is 1.5 minutes). During the other 8.5 minutes of the 10 minute period the Welding Power Source must idle and allowed to cool.

2.10 Specifications

| Description | WeldSkill 200HF |
|---|--|
| Plant Part No | W1008200 |
| Power Source Dimensions (excludes handle & gas nipple) | H245mm × W145mm × D420mm |
| Power Source Mass | 8.2 kg |
| Cooling | Fan Cooled |
| Welder Type | HF TIG, Lift TIG and Stick Multi Process Inverter Power Source |
| Australian Standard | AS 60974.1-2006 / IEC 60974-1 |
| Number of Phases | Single Phase |
| Nominal Supply Voltage | 240 VAC ± 10% |
| Nominal Supply Frequency | 50/60 Hz |
| Welding Current Range - TIG | 10 - 200 A |
| Welding Current Range - Stick | 10 - 180 A |
| Nominal DC Open Circuit Voltage | 75 V |
| Factory Fitted Supply Plug Rating | 15 Amps |
| Effective Input Current (I _{1eff}) (refer Note 2) | 15 Amps |
| Maximum Input Current (I _{1max}) | 33.9 Amps |
| Minimum Single Phase Generator Recommendation (refer Note 4) | 7.6 kW (9.5 kVA at 0.8 PF) |
| STICK (MMAW) Welding Output, 40°C, 10 min. | 180 A @ 20%, 27.2 V |
| | 147 A @ 30%, 25.9 V |
| | 110 A @ 60%, 24.4 V |
| | 90 A @ 100%, 23.6 V |
| TIG (GTAW) Welding Output, 40°C, 10 min. | 200 A @ 30%, 18.0 V |
| | 155 A @ 60%, 16.2 V |
| | 130 A @ 100%, 15.2 V |
| Protection Class | IP21S |

Table 2-1: Specifications

NOTE 1

Due to variations that can occur in manufactured products, claimed performance, voltages, ratings, all capacities, measurements, dimensions and weights quoted are approximate only. Achievable capacities and ratings in use and operation will depend upon correct installation, use, applications, maintenance and service.

NOTE 2

The Effective Input Current should be used for the determination of cable size & supply requirements.

NOTE 3

Motor start fuses or thermal circuit breakers are recommended for this application. Check local requirements for your situation in this regard.

NOTE 4

Minimum Generator Recommendation at the Maximum Output Duty Cycle.

Due to large variations in performance and specifications of different brands and types of generators, CIGWELD cannot guarantee full welding output power or duty cycle on every brand or type of generator.

Some small generators incorporate low cost circuit breakers on their outputs. These circuit breakers usually will have a small reset button, and will trip much faster than a switchboard type circuit breaker. This may result in not being able to achieve full output or duty cycle from the power source / generator combination. For this reason we recommend a generator that incorporates switchboard type circuit breakers.

CIGWELD recommends that when selecting a generator, that the particular power source / generator combination be adequately trialled to ensure the combination performs to the users expectations.

NOTE 5

CIGWELD reserves the right to change product performance and specifications without notice.

2.11 Optional Accessories

We recommend genuine CIGWELD products.

The biggest range and best quality with guaranteed performance.

| Part Number | Description |
|-------------|---|
| W4014604 | TIG Torch 26F with Flex Head, 4m lead, 50mm Dinse Plug, Trigger Switch and Remote Control |
| BGSAK2 | TIG Torch Accessory Kit for 17, 26 & 18 TIG Torches |
| 210254 | WeldSkill Argon Regulator/Flowmeter, 55LPM, 2 Gauge |
| OTD10/4016 | Foot Control with 7.6m lead with 8 pin plug |
| WS42550 | WeldSkill Welding Leadset 4m, 25mm ² cable, 50mm ² dinse, 250A Twistlock Electrode Holder |
| WS53550 | WeldSkill Welding Leadset 5m, 35mm ² cable, 50mm ² dinse, 400A Twistlock Electrode Holder |

Table 2-2

2.11 Optional Accessories (Cont'd)

TIG Torch Consumables

| Part Number | Description |
|-------------|---|
| BG10N49/R | Nozzle Alumina 8mm, for 17, 26 & 18 TIG Torches (pkt of 5) |
| BG10N48/R | Nozzle Alumina 10mm, for 17, 26 & 18 TIG Torches (pkt of 5) |
| BG10N47/R | Nozzle Alumina 11mm, for 17, 26 & 18 TIG Torches (pkt of 5) |
| BG10N46/R | Nozzle Alumina 12.5mm, for 17, 26 & 18 TIG Torches (pkt of 5) |
| BG10N22/R | Collet 1.0mm, for 17, 26 & 18 TIG Torches (pkt of 5) |
| BG10N23/R | Collet 1.6mm, for 17, 26 & 18 TIG Torches (pkt of 5) |
| BG10N24/R | Collet 2.4mm, for 17, 26 & 18 TIG Torches (pkt of 5) |
| BG10N25/R | Collet 3.2mm, for 17, 26 & 18 TIG Torches (pkt of 5) |
| BG10N30/R | Collet Body 1.0mm, for 17, 26 & 18 TIG Torches (pkt of 5) |
| BG10N31/R | Collet Body 1.6mm, for 17, 26 & 18 TIG Torches (pkt of 5) |
| BG10N32/R | Collet Body 2.4mm, for 17, 26 & 18 TIG Torches (pkt of 5) |
| BG10N28/R | Collet Body 3.2mm, for 17, 26 & 18 TIG Torches (pkt of 5) |
| BG57Y02/R | Back Cap – Long for 17, 26 & 18 TIG Torches (pkt of 2) |
| BG57Y04/R | Back Cap – Short for 17, 26 & 18 TIG Torches (pkt of 2) |

Table 2-3

TIG Electrodes

| Part Number | Description |
|-------------|---|
| 699846 | Ceriated Electrode 1.6mm x 175mm AC/DC Grey (Pkt of 10) |
| 699847 | Ceriated Electrode 2.4mm x 175mm AC/DC Grey (Pkt of 10) |
| 699848 | Ceriated Electrode 3.2mm x 175mm AC/DC Grey (Pkt of 10) |

Table 2-4

Related Products

| Part Number | Description |
|-------------|--|
| 646754 | WeldSkill TIG Welding Gloves |
| 646755 | WeldSkill Heavy Duty Welding Gloves |
| 454304 | WeldSkill Auto Darkening Welding Helmet Fixed Shade 11 Black |
| 454305 | WeldSkill Auto Darkening Welding Helmet Variable Shade 9-13 Blue |
| 454314 | WeldSkill Auto Darkening Welding Helmet Variable Shade 9-13 Carbon Fibre |
| 454321 | WeldSkill Auto Darkening Welding Helmet Variable Shade 9-13 Racer |
| 454322 | WeldSkill Auto Darkening Welding Helmet Variable Shade 9-13 Tribal |
| 454323 | WeldSkill Auto Darkening Welding Helmet Variable Shade 9-13 White Carbon |
| 454324 | WeldSkill Auto Darkening Welding Helmet Variable Shade 9-13 Oz Flag |

Note: CIGWELD Electrodes see page 6-2 and 6-3

Table 2-5

SECTION 3: INSTALLATION

3.01 Environment

These units are designed for use in environments with increased hazard of electric shock.

A. Examples of environments with increased hazard of electric shock are:

1. In locations in which freedom of movement is restricted, so that the operator is forced to perform the work in a cramped (kneeling, sitting or lying) position with physical contact with conductive parts.
2. In locations which are fully or partially limited by conductive elements, and in which there is a high risk of unavoidable or accidental contact by the operator.

B. Environments with increased hazard of electric shock do not include places where electrically conductive parts in the near vicinity of the operator, which can cause increased hazard, have been insulated.

3.02 Location

Be sure to locate the welder according to the following guidelines:

- A. In areas, free from moisture and dust.
- B. Ambient temperature between 0° C to 40° C.
- C. In areas, free from oil, steam and corrosive gases.
- D. In areas, not subjected to abnormal vibration or shock.
- E. In areas, not exposed to direct sunlight or rain.
- F. Place at a distance of 300mm or more from walls or similar that could restrict natural air flow for cooling.

3.03 Ventilation

Since the inhalation of welding fumes can be harmful, ensure that the welding area is effectively ventilated.

3.04 Mains Supply Voltage Requirements

The Mains supply voltage should be within $\pm 10\%$ of the rated Mains supply voltage. If actual Mains Supply Voltage is outside this range Welding Current may not be available and may cause internal components to fail.

Refer to Specifications on page 2-4 for Supply Voltage information.

The Welding Power Source must be:

- Correctly installed, if necessary, by a qualified electrician.
- Correctly earthed (electrically) in accordance with local regulations.
- Connected to the correct size power point and fuse as per the Specifications on page 2-4.

IMPORTANT NOTE

This product has been fitted with a supply plug as indicated in Section 2.10. Note that the welding output range applicable with the fitted supply plug is detailed in Section 2.10.



WARNING

Any electrical work must be carried out by a qualified Electrical Tradesperson.

3.05 Generators

Refer to Note 4 on page 2-5 for recommendations when using with a Generator.

3.06 Electromagnetic Compatibility

**WARNING**

Extra precautions for Electromagnetic Compatibility may be required when this Welding Power Source is used in a domestic situation.

A. Installation and Use - Users Responsibility

The user is responsible for installing and using the welding equipment according to the manufacturer's instructions. If electromagnetic disturbances are detected then it shall be the responsibility of the user of the welding equipment to resolve the situation with the technical assistance of the manufacturer. In some cases this remedial action may be as simple as earthing the welding circuit, see NOTE below. In other cases it could involve constructing an electromagnetic screen enclosing the Welding Power Source and the work, complete with associated input filters. In all cases, electromagnetic disturbances shall be reduced to the point where they are no longer troublesome.

NOTE

The welding circuit may or may not be earthed for safety reasons. Changing the earthing arrangements should only be authorised by a person who is competent to assess whether the changes will increase the risk of injury, e.g. by allowing parallel welding current return paths which may damage the earth circuits of other equipment. Further guidance is given in IEC 974-13 Arc Welding Equipment - Installation and use (under preparation).

B. Assessment of Area

Before installing welding equipment, the user shall make an assessment of potential electromagnetic problems in the surrounding area. The following shall be taken into account

1. Other supply cables, control cables, signalling and telephone cables; above, below and adjacent to the welding equipment.
2. Radio and television transmitters and receivers.
3. Computer and other control equipment.
4. Safety critical equipment, e.g. guarding of industrial equipment.
5. The health of people around, e.g. the use of pacemakers and hearing aids.

6. Equipment used for calibration and measurement.
7. The time of day that welding or other activities are to be carried out.
8. The immunity of other equipment in the environment: the user shall ensure that other equipment being used in the environment is compatible: this may require additional protection measures.

The size of the surrounding area to be considered will depend on the structure of the building and other activities that are taking place. The surrounding area may extend beyond the boundaries of the premises.

C. Methods of Reducing Electromagnetic Emissions

1. Mains Supply

Welding equipment should be connected to the mains supply according to the manufacturer's recommendations. If interference occurs, it may be necessary to take additional precautions such as filtering of the mains supply. Consideration should be given to shielding the supply cable of permanently installed welding equipment in metallic conduit or equivalent. Shielding should be electrically continuous throughout its length. The shielding should be connected to the Welding Power Source so that good electrical contact is maintained between the conduit and the Welding Power Source enclosure.

2. Maintenance of Welding Equipment

The welding equipment should be routinely maintained according to the manufacturer's recommendations. All access and service doors and covers should be closed and properly fastened when the welding equipment is in operation. The welding equipment should not be modified in any way except for those changes and adjustments covered in the manufacturer's instructions. In particular, the spark gaps of arc striking and stabilising devices should be adjusted and maintained according to the manufacturer's recommendations.

3. Welding Cables

The welding cables should be kept as short as possible and should be positioned close together, running at or close to the floor level.

4. Equipotential Bonding

Bonding of all metallic components in the welding installation and adjacent to it should be considered. However, metallic components bonded to the work piece will increase the risk that the operator could receive a shock by touching the metallic components and the electrode at the same time. The operator should be insulated from all such bonded metallic components.

5. Earthing of the Workpiece

Where the workpiece is not bonded to earth for electrical safety, nor connected to earth because of its size and position, e.g. ship's hull or building steelwork, a connection bonding the workpiece to earth may reduce emissions in some, but not all instances. Care should be taken to prevent the earthing of the workpiece increasing the risk of injury to users, or damage to other electrical equipment. Where necessary, the connection of the workpiece to earth should be made by direct connection to the workpiece, but in some countries where direct connection is not permitted, the bonding should be achieved by suitable capacitance, selected according to national regulations.

6. Screening and Shielding

Selective screening and shielding of other cables and equipment in the surrounding area may alleviate problems of interference. Screening the entire welding installation may be considered for special applications.

This Page Intentionally Blank

SECTION 4: OPERATION

4.01 Overview

Conventional operating procedures apply when using the Welding Power Source, i.e. connect work lead directly to workpiece and electrode lead is used to hold electrode (Consult the electrode manufacturers information for the correct polarity). The welding current range values should be used as a guide only. Current delivered to the arc is dependent on the welding arc voltage, and as welding arc voltage varies between different classes of electrode, welding current at any one setting would vary according to the type of electrode in use. The operator should use the welding current range values as a guide, then finally adjust the current setting to suit the application.

4.02 Power Source Controls, Indicators and Features

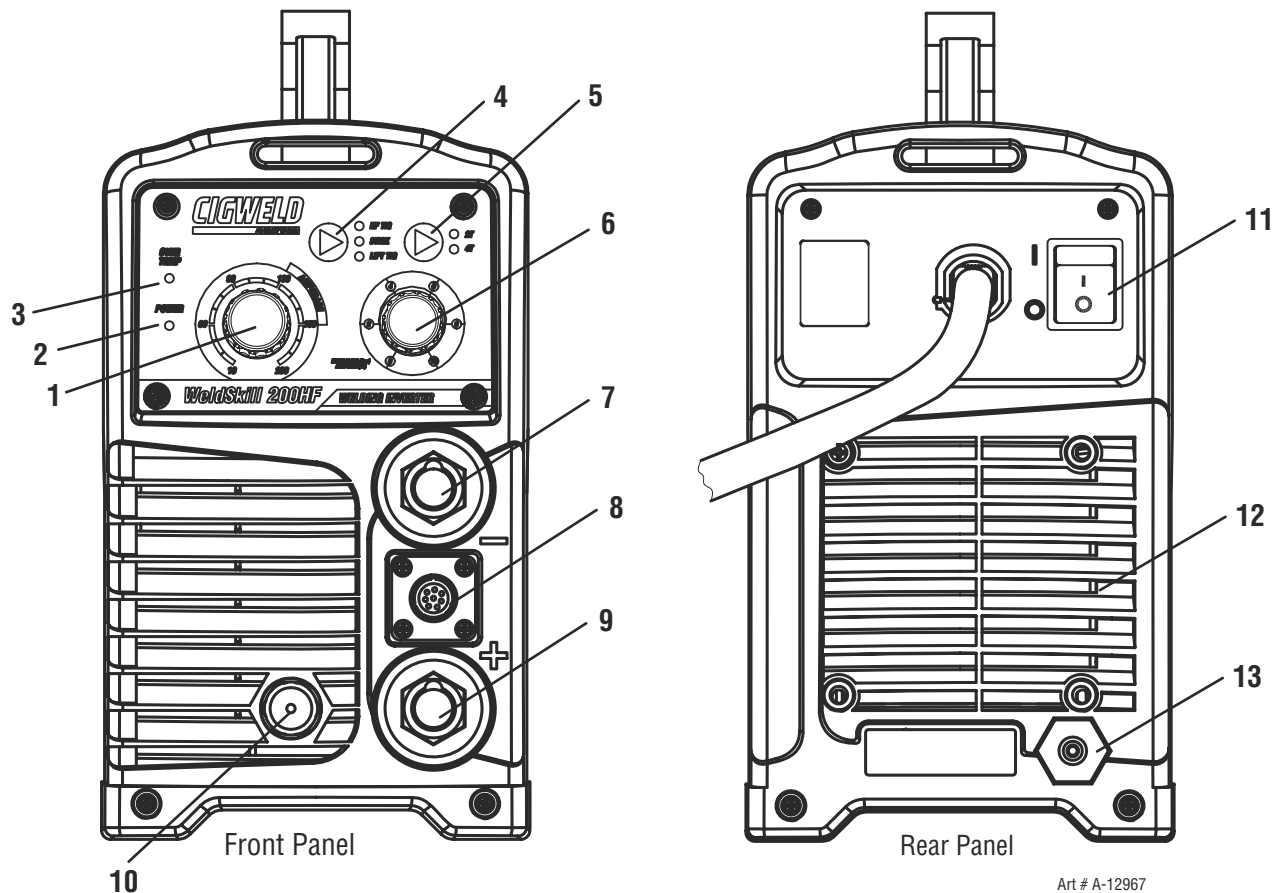

Figure 4-1: Front and Rear Panel

1. Amperage Control (Welding Current)

The amperage control knob adjusts the amount of welding current delivered by the power source. The amperage is increased by turning the amperage clockwise or decreased by turning the amperage control knob anti-clockwise. The amperage should be set according to the electrode type and the specific application. Refer to application notes in this manual for further information.

2. Power Indicator

The power indicator is illuminated when nominal 240V AC mains power is applied to the power source and the ON/OFF switch located on the rear panel is in the ON position.

3. Over Temp Indicator

This welding power source is protected by a self resetting thermostat. The Over Temp indicator will illuminate if the machine has over heated which normally occurs if the duty cycle of the power source has been exceeded. Should the Over Temp indicator illuminate the output of the power source will be disabled. Leave the power source turned On to allow the internal components to cool down. Once the power source cools down sufficiently the Over Temp indicator will automatically go off. Note that the On/Off switch should remain in the On position such that the fan continues to operate thus allowing the power source to cool sufficiently.

4. Process Selection Control

The process selection control is used to select the desired welding mode. Three modes are available, HF TIG, Stick and Lift TIG modes. Refer to section 5.02 for TIG (GTAW) set-up details or section 6.01 for Stick (MMAW) set-up details .

5. Trigger Mode Control (Lift TIG and HF TIG Modes only)

The trigger mode control is used to switch the functionality of the torch trigger between 2T (normal), and 4T (latch mode).

2T (Normal Mode)

In this mode, the torch trigger must remain depressed for the welding output to be active. Press and hold the torch trigger to activate the power source (weld). Release the torch trigger switch to cease welding.

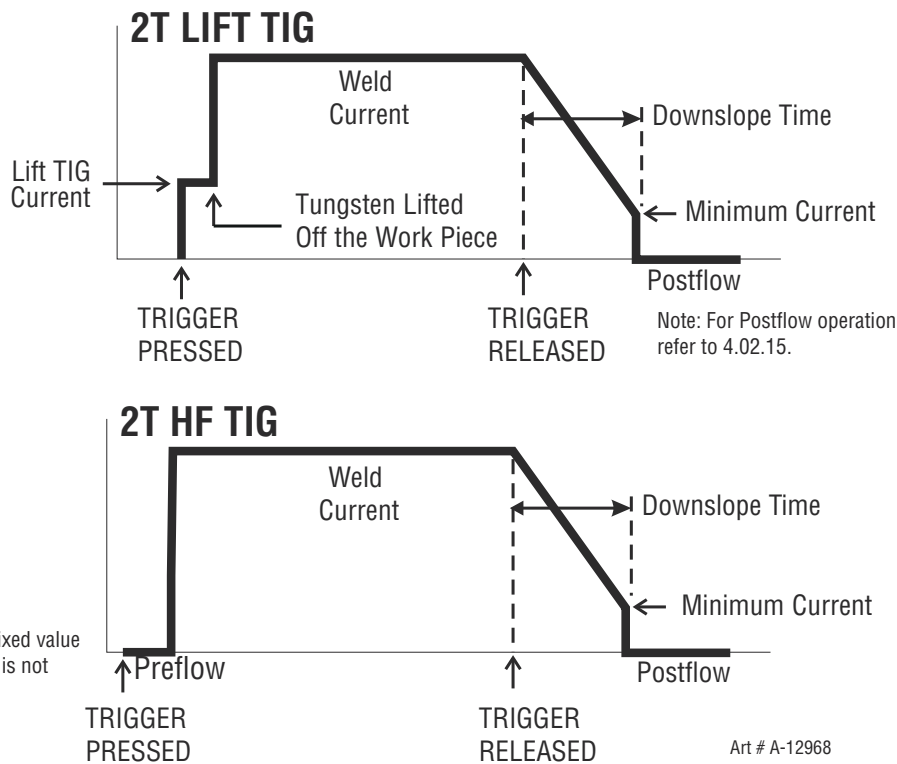

Figure 4-2: 2T Timing Sequence

4T (Latch Mode)

This mode of welding is mainly used for long welding runs to reduce operator fatigue. In this mode the operator can press and release the torch trigger and the output will remain active. To deactivate the power source, the trigger switch must again be depressed and realised, thus eliminating the need for the operator to hold the torch trigger.

NOTE

(Optional) Foot Control will not work properly in 4T mode and should not be used in this mode.

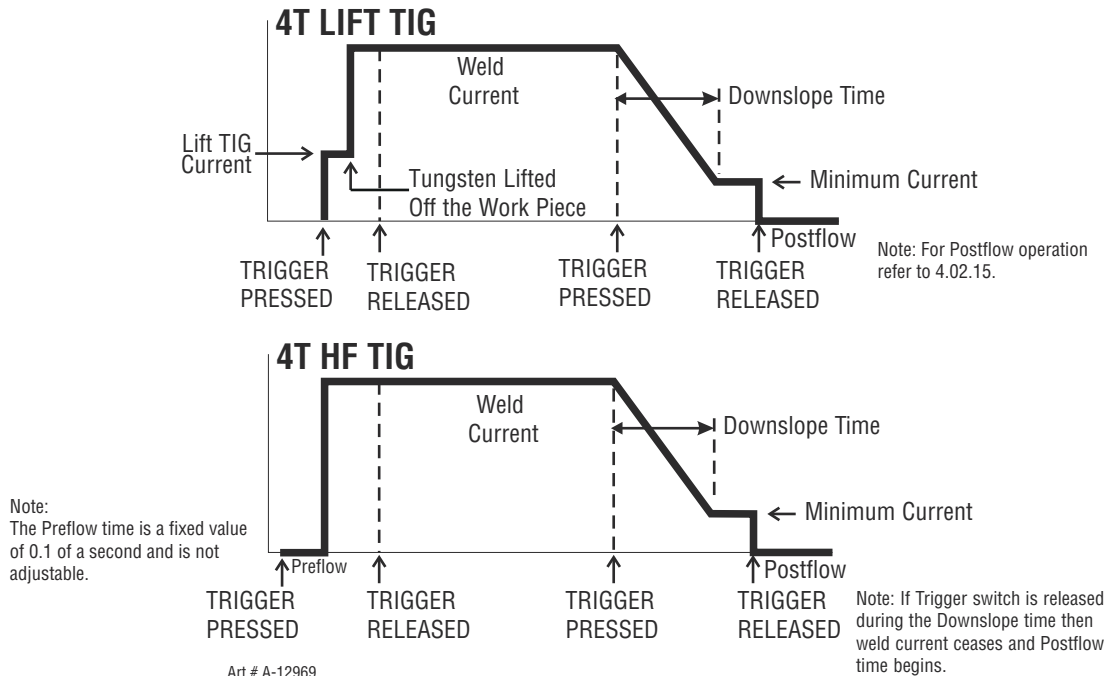

Figure 4-3: 4T Timing Sequence

Note that when operating in GTAW (LIFT TIG & HF TIG modes), the power source will remain activated until the selected down slope time has elapsed. At any time whilst in 4T Mode if the TIG Torch Trigger Switch is depressed and released welding will cease immediately.

6. Arc Force/Down Slope Control

Arc Force Feature (Not Shown)

This feature operates in Stick (Manual Arc) mode.

Stick electrodes can sometimes 'stick' to the work piece when pushed into a tight corner or joint fit-up with particular stick electrodes. The Arc force feature can be particularly beneficial in helping to overcome this by automatically increasing current when the machine senses a decrease in voltage levels. with particular electrodes. In general increasing the Arc Force control toward '10' (maximum Arc Force) allows greater penetration control to be achieved.

Down Slope

Downslope is used to set the time for weld current to ramp down.

Note: When using an (optional) Foot Control it is recommended that the downslope control is turned to 0 (minimum) and downslope is controlled manually by the Foot Control.

Down Slope in 2T (Normal Mode)

Whilst welding if the TIG Torch Trigger Switch is released, the welding current ramps down to zero current over a defined period of time. The time period is determined by the setting of the Downslope Control Knob. Downslope Range is 0 to 10 seconds.

Down Slope in 4T (Latch Mode)

To activate the Downslope function in 4T (Latch Mode) whilst welding, the TIG Torch Trigger Switch must be depressed and held which will ramp the Welding Current down to zero over a defined period of time. The time period is determined by the Downslope Control Knob. Downslope Range is 0 to 10 seconds.

At any time whilst welding in 4T (Latch Mode) if the TIG Torch Trigger Switch is depressed and released welding will cease immediately.

7. Negative Welding Output Terminal

The negative welding terminal is used to connect the welding output of the power source to the work lead. Most General Purpose electrodes are connected with work lead to negative. Consult the electrode manufacturer's information for the correct polarity.

Welding current flows from the workpiece via this Dinse type terminal to the power source. It is essential, however, that the male dinse type plug is inserted and turned securely to achieve a sound electrical connection. Do not over tighten.

CAUTION 1

Loose welding terminal connections can cause overheating and result in the male plug being fused in the Dinse terminal.

8. Control Socket 8 Pin

The 8 pin socket on the power source is used to connect a trigger switch or remote control device i.e foot control, to the welding Power Source

To make connections, align keyway, insert plug, and rotate threaded collar fully clockwise. The socket information is included in the event the supplied cable/plug is not suitable or the remote device plug or cable is damaged and it is necessary to wire a plug or cable to interface with the 8 pin receptacle.

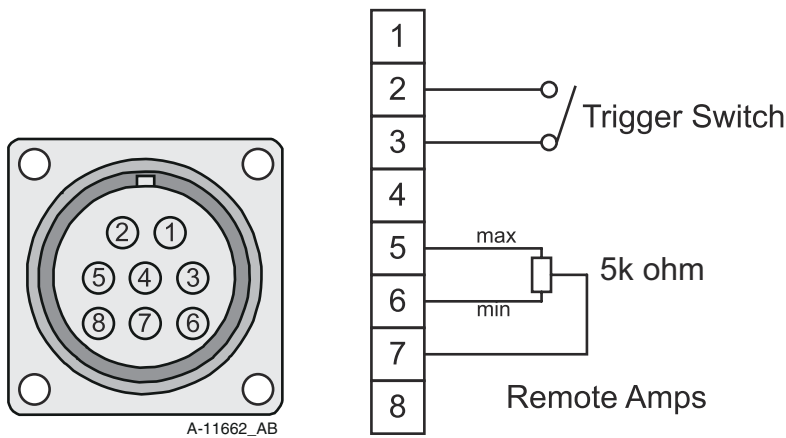

Figure 4-4: Remote Control Socket

| Socket Pin | Function |
|------------|---|
| 1 | Not connected |
| 2 | Trigger Switch Input |
| 3 | Trigger Switch Input |
| 4 | Not connected |
| 5 | 5k ohm (maximum) connection to 5k ohm remote control potentiometer. |
| 6 | Zero ohm (minimum) connection to 5k ohm remote control potentiometer. |
| 7 | Wiper arm connection to 5k ohm remote control Amps GTAW (TIG) mode potentiometer. |
| 8 | Not connected. |

Table 4-1

9. Positive Welding Output Terminal

The positive welding terminal is used to connect the welding output of the power source to the electrode holder lead. Most General Purpose electrodes are connected with electrode to positive. Consult the electrode manufacturer's information for the correct polarity.

Positive welding current flows from the power source via this Dinse type terminal. It is essential, however, that the male Dinse type plug is inserted and turned securely to achieve a sound electrical connection. Do not over tighten.

CAUTION 2

Loose welding terminal connections can cause overheating and result in the male plug being fused in the Dinse terminal.

10. Shielding Gas Outlet

The Shielding Gas Outlet located on the front panel is a 5/8-18 UNF female gas fitting and is utilised for the connection of a suitable TIG Torch.

11. On/Off Switch

This switch is used to turn the unit ON/OFF. When this switch is turned ON the Power Indicator on the front panel will illuminate.

12. Fan

The Fan is turned ON/OFF by the Power Switch on the rear panel of the machine.

13. Shielding Gas Inlet

The Shielding Gas Inlet connection is a quick connect type and is used to supply the appropriate shielding gas to the unit. Refer to section 5.02 for TIG (GTAW) set up details.

14. Hot Start Feature (Not Shown)

This feature operates in Stick (Manual Arc) mode. The Hot Start feature improves the arc start characteristics by momentarily increasing the welding current to a level above the preset amperage (Welding Current). This is a preset feature and is not adjustable.

15. Post Gas Flow (Not Shown)

This parameter operates in TIG modes only. Post Gas Flow is the time Gas flows after the arc has extinguished. This is used to cool and reduce oxidation of the Tungsten Electrode.

Post Gas Flow time is proportional to the Welding Current setting. For example if the Welding Current is set to 10 amps the Post Gas Flow time will be approximately 1 second. For a Welding Current set to 200 Amps the Post Gas Flow time will be approximately 8 seconds. The Post Gas Flow time cannot be adjusted independently of the Welding Current.

16. Anti Stick Feature (Not Shown)

This feature operates in Stick (Manual Arc) mode.

The anti stick feature senses when the electrode sticks and automatically reduces the current to prevent the Stick Electrode from sticking to the work piece. This is a preset feature and is not adjustable.

This Page Intentionally Blank

SECTION 5: TIG (GTAW) WELDING

5.01 Shielding Gas Regulator/Flowmeter Operating Instructions

**WARNING**

This equipment is designed for use with welding grade (Inert) shielding gases only.

Shielding Gas Regulator/Flowmeter Safety

This regulator/flowmeter is designed to reduce and control high pressure gas from a cylinder or pipeline to the working pressure required for the equipment using it.

If the equipment is improperly used, hazardous conditions are created that may cause accidents. It is the users responsibility to prevent such conditions. Before handling or using the equipment, understand and comply at all times with the safe practices prescribed in this instruction.

SPECIFIC PROCEDURES for the use of regulators/flowmeters are listed below.

1. NEVER subject the regulator/flowmeter to inlet pressure greater than its rated inlet pressure.
2. NEVER pressurize a regulator/flowmeter that has loose or damaged parts or is in a questionable condition. NEVER loosen a connection or attempt to remove any part of a regulator/flowmeter until the gas pressure has been relieved. Under pressure, gas can dangerously propel a loose part.
3. DO NOT remove the regulator/flowmeter from a cylinder without first closing the cylinder valve and releasing gas in the regulator/flowmeter high and low pressure chambers.
4. DO NOT use the regulator/flowmeter as a control valve. When downstream equipment is not in use for extended periods of time, shut off the gas at the cylinder valve and release the gas from the equipment.
5. OPEN the cylinder valve SLOWLY. Close after use.

User Responsibilities

This equipment will perform safely and reliable only when installed, operated and maintained, and repaired in accordance with the instructions provided. Equipment must be checked periodically and repaired, replaced, or reset as necessary for continued safe and reliable performance. Defective equipment should not be used. Parts that are broken, missing, obviously worn, distorted, or contaminated should be replaced immediately.

The user of this equipment will generally have the sole responsibility for any malfunction, which results from improper use, faulty maintenance, or by repair by anyone other than an accredited repairer.

**CAUTION**

Match regulator/flowmeter to cylinder. NEVER CONNECT a regulator/flowmeter designed for a particular gas or gases to a cylinder containing any other gas.

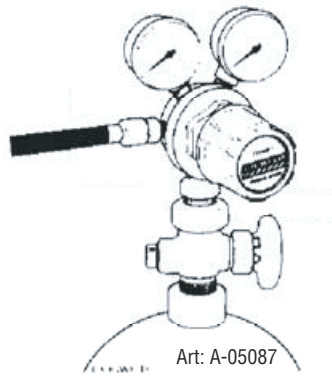

Figure 5-1: Fit Regulator/flowmeter to Cylinder

Installation

1. Remove cylinder valve plastic dust seal. Clean the cylinder valve outlet of impurities that may clog orifices and damage seats before connecting the regulator/flowmeter.

Crack the valve (open then close) momentarily, pointing the outlet away from people and sources of ignition. Wipe with a clean lint free cloth.

2. Match regulator/flowmeter to cylinder. Before connecting, check that the regulator/flowmeter label and cylinder marking agree and that the regulator/flowmeter inlet and cylinder outlet match. NEVER CONNECT a regulator/flowmeter designed for a particular gas or gases to a cylinder containing any other gas.
3. Connect the regulator/flowmeter inlet connection to cylinder or pipeline and tighten it firmly but not excessively, with a suitable spanner.
4. Connect and tighten the outlet hose firmly and attach down-stream equipment.
5. To protect sensitive down-stream equipment a separate safety device may be necessary if the regulator/flowmeter is not fitted with a pressure relief device.

Operation

With the regulator/flowmeter connected to cylinder or pipeline, and the adjustment screw/knob fully disengaged, pressurize as follows:

1. Stand to one side of regulator/flowmeter and slowly open the cylinder valve. If opened quickly, a sudden pressure surge may damage internal regulator/flowmeter parts.
2. With valves on downstream equipment closed, adjust regulator/flowmeter to approximate working pressure. It is recommended that testing for leaks at the regulator/flowmeter connection points be carried out using a suitable leak detection solution or soapy water.
3. Purge air or other unwanted welding grade shielding gas from equipment connected to the regulator/flowmeter by individually opening then closing the equipment control valves. Complete purging may take up to ten seconds or more, depending upon the length and size of the hose being purged.

Adjusting Flow Rate

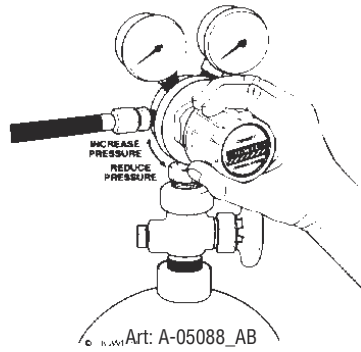

Figure 5-2: Adjust Flow Rate

With the regulator/flowmeter ready for operation, adjust working flow rate as follows:

1. Slowly turn adjusting screw/knob in (clockwise) direction until the outlet gauge indicates the required flow rate.

NOTE

It may be necessary to re-check the shielding gas regulator/flowmeter flow rate following the first weld sequence due to back pressure present within shielding gas hose assembly.

2. To reduce flow rate, allow the welding grade shielding gas to discharge from regulator/flowmeter by opening the downstream valve. Bleed welding grade shielding gas into a well ventilated area and away from any ignition source. Turn adjusting screw counterclockwise, until the required flow rate is indicated on the gauge. Close downstream valve.

Shutdown

Close cylinder valve whenever the regulator/flowmeter is not in use. To shut down for extended periods (more than 30 minutes).

1. Close cylinder or upstream valve tightly.
2. Open downstream equipment valves to drain the lines. Bleed gas into a well ventilated area and away from any ignition source.
3. After gas is drained completely, disengage adjusting screw and close downstream equipment valves.
4. Before transporting cylinders that are not secured on a cart designed for such purposes, remove regulators/flowmeters.

5.02 Setup For TIG (GTAW) Welding

- A. Select HF TIG or Lift TIG mode with the process selection control (refer to Section 4.02.4 for further information).
- B. Connect the TIG torch trigger switch via the 8 pin socket located on the front of the power source as shown in Figure 5-3. The TIG torch will require a trigger switch to operate in HF TIG and Lift TIG Mode.
- C. Connect the TIG Torch to the negative welding terminal (-). Welding current flows from the power source via Dinse terminals. It is essential, however, that the male plug is inserted and turned securely to achieve a sound electrical connection.
- D. Connect the work lead to the positive welding terminal (+). Welding current flows from the Power Source via Dinse terminals. It is essential, however, that the male plug is inserted and turned securely to achieve a sound electrical connection.
- E. Connect the TIG Torch Gas hose connection to the Shielding Gas Outlet on the front of the WeldSkill 200HF power source (refer to Section 4.02.10 for further information). Ensure that this connection is sufficiently tight so that it does not leak.

NOTE

If the TIG torch has a remote TIG torch current control fitted then it will require to be connected to the 8 pin socket. (Refer to section 4.02.8 Remote Control Socket for further information).

- F. Fit the welding grade shielding gas regulator/flowmeter to the shielding gas cylinder (refer to Section 5.01) then connect the shielding gas hose from the shielding gas regulator/flowmeter outlet to the quick connect Shielding Gas Inlet fitting gas on the rear of the WeldSkill 200HF Power Source. Ensure that the shielding gas hose connection is sufficiently tight at the regulator connection and the quick connect fitting "locks" into place correctly on the rear of the WeldSkill 200HF power source.



WARNING

Secure the welding grade shielding gas cylinder in an upright position by chaining it to a suitable stationary support to prevent falling or tipping.



WARNING

Before connecting the work clamp to the work and inserting the electrode in the TIG torch make sure the Mains power supply is switched off.



CAUTION

Remove any packaging material prior to use. Do not block the air vents at the front or rear of the Welding Power Source.



CAUTION

Loose welding terminal connections can cause overheating and result in the male plug being fused in the terminal

See next page for Setup for TIG (GTAW) Welding.

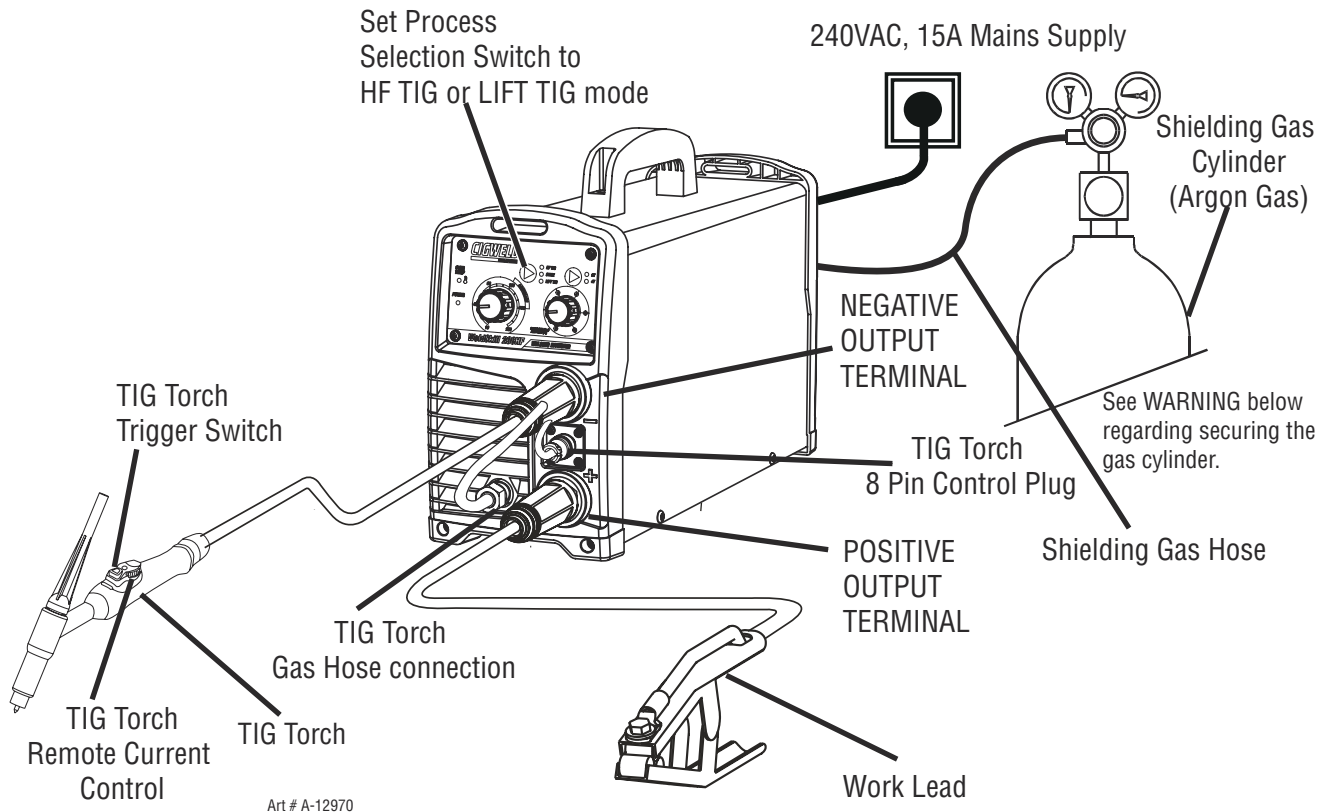

Figure 5-3: Setup for TIG (GTAW) Welding



WARNING

Secure the welding grade shielding gas cylinder in an upright position by chaining it to a suitable stationary support to prevent falling or tipping.

5.03 TIG (GTAW) Basic Welding Technique

Gas Tungsten Arc Welding (GTAW) or TIG (Tungsten Inert Gas) as it is commonly referred to, is a welding process in which fusion is produced by an electric arc that is established between a single tungsten (non-consumable) electrode and the work piece. Shielding is obtained from a welding grade shielding gas or welding grade shielding gas mixture which is generally Argon based. A filler metal may also be added manually in some circumstances depending on the welding application.

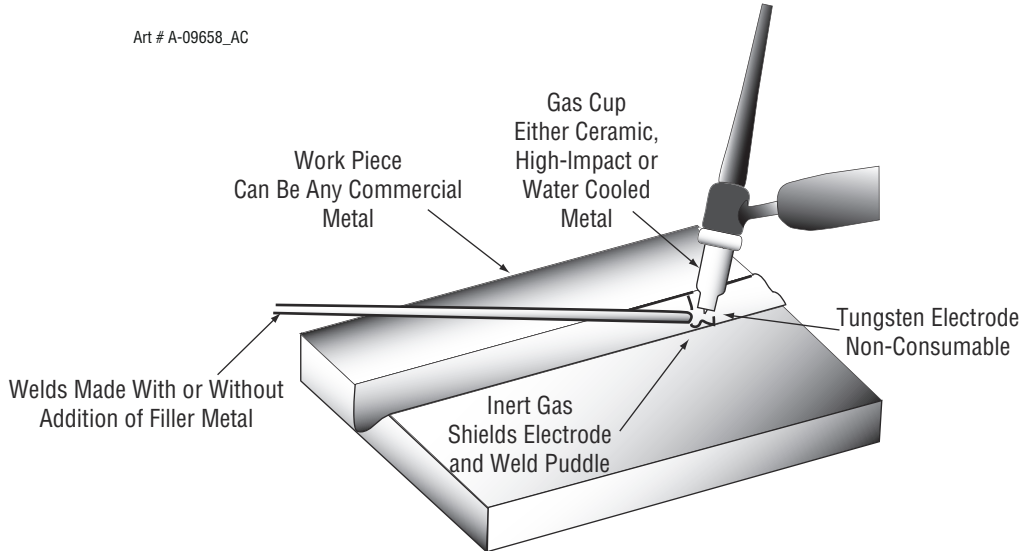

Figure 5-4: TIG Welding Application Shot

Tungsten Electrode Current Ranges

| Electrode Diameter | DC Current (Amps) |
|--------------------|-------------------|
| 0.040" (1.0mm) | 30-60 |
| 1/16" (1.6mm) | 60-115 |
| 3/32" (2.4mm) | 100-165 |
| 1/8" (3.2mm) | 135-200 |
| 5/32" (4.0mm) | 190-280 |
| 3/16" (4.8mm) | 250-340 |

Table 5-1: Current Ranges for Various Tungsten Electrode Sizes

Guide for Selecting Filler Wire Diameter

| Filler Wire Diameter | DC Current Range (Amps) |
|----------------------|-------------------------|
| 1/16" (1.6mm) | 20-90 |
| 3/32" (2.4mm) | 65-115 |
| 1/8" (3.2mm) | 100-165 |
| 3/16" (4.8mm) | 200-350 |

Table 5-2: Filler Wire Selection Guide

NOTE

The operator should use the welding current range values as a guide only, then finally adjust the current setting to suit the application.

Tungsten Electrode Types

| Electrode Type (Ground Finish) | Welding Application | Features | Colour Code |
|-----------------------------------|---|---|-------------|
| Ceriated 2% | AC & DC welding of mild steel, stainless steel, copper, aluminium, magnesium and their alloys | Longer life, More stable arc, Easier starting, Wider current range, Narrower more concentrated arc. | Grey |

Table 5-3

TIG Welding Filler Rods

| Comweld Rod | Aust Std | AWS Std | Part No. 1.6mm | Part No. 2.4mm | Part No. 3.2mm | Type/Application |
|----------------------------|-------------------------|-------------------------------|----------------------------|----------------------------|-------------------|--|
| LW1 LW1-6 Supersteel | R4 R6 R2 | ER70S-4 ER70S-6 ER70S-2 | 321411 321417 321370 | — — — | — — — | For mild-medium strength steels. Pipes, tubing, roll cages, etc. |
| CrMo1 CrMo2 | RB2 RB3 | ER80S-B2 ER90S-B3 | — — | 321379 321383 | — — | For welding of high strength Cr-Mo steels used at elevated temperatures. |
| 308L 309L 316L | R308L R309L R316L | ER308L ER309L ER316L | 321406 321403 321400 | 321407 321404 321401 | — — — | For stainless steels. Stainless pipes, tubing, architectural uses, etc. |

Table 5-4

| Base Metal Thickness | DC Current for Mild Steel | DC Current for Stainless Steel | Tungsten Electrode Diameter | Filler Rod Diameter (if required) | Argon Gas Flow Rate Litres/min | Joint Type |
|----------------------|---------------------------|--------------------------------|-----------------------------|-----------------------------------|--------------------------------|---------------------------|
| 0.040" 1.0mm | 35-45 40-50 | 20-30 25-35 | 0.040" 1.0mm | 1/16" 1.6mm | 5-7 | Butt/Corner Lap/Fillet |
| 0.045" 1.2mm | 45-55 50-60 | 30-45 35-50 | 0.040" 1.0mm | 1/16" 1.6mm | 5-7 | Butt/Corner Lap/Fillet |
| 1/16" 1.6mm | 60-70 70-90 | 40-60 50-70 | 1/16" 1.6mm | 1/16" 1.6mm | 7 | Butt/Corner Lap/Fillet |
| 1/8" 3.2mm | 80-100 90-115 | 65-85 90-110 | 1/16" 1.6mm | 3/32" 2.4mm | 7 | Butt/Corner Lap/Fillet |
| 3/16" 4.8mm | 115-135 140-165 | 100-125 125-150 | 3/32" 2.4mm | 1/8" 3.2mm | 10 | Butt/Corner Lap/Fillet |
| 1/4" 6.4mm | 160-175 170-200 | 135-160 160-180 | 1/8" 3.2mm | 5/32" 4.0mm | 10 | Butt/Corner Lap/Fillet |

Table 5-5

TIG Welding is generally regarded as a specialised process that requires operator competency. While many of the principles outlined in the previous Arc Welding section are applicable a comprehensive outline of the TIG Welding process is outside the scope of this Operating Manual. For further information please refer to www.cigweld.com.au or contact Cigweld.

5.04 TIG (GTAW) Welding Problems

| FAULT | CAUSE | REMEDY |
|---|---|---|
| 1 Excessive bead build up or poor penetration or poor fusion at edges of weld. | Welding current is too low | Increase weld current and/or faulty joint preparation. |
| 2 Weld bead too wide and flat or undercut at edges of weld or excessive burn through. | Welding current is too high | Decrease weld current. |
| 3 Weld bead too small or insufficient penetration or ripples in bead are widely spaced apart. | Travel speed too fast | Reduce travel speed. |
| 4 Weld bead too wide or excessive bead build up or excessive penetration in butt joint. | Travel speed too slow | Increase travel speed. |
| 5 Uneven leg length in fillet joint | Wrong placement of filler rod | Re-position filler rod. |
| 6 Electrode melts or oxidises when an arc is struck. | <p>A Torch lead connected to positive welding terminal.</p> <p>B No shielding gas flowing to welding region.</p> <p>C Torch is clogged with dust or dirt.</p> <p>D Shielding gas hose is damaged.</p> <p>E Shielding Gas passage contains impurities.</p> <p>F Shielding gas regulator turned off.</p> <p>G The electrode is too small for the welding current.</p> | <p>A Connect torch lead to negative welding terminal.</p> <p>B Check the shielding gas lines for kinks or breaks and shielding gas cylinder contents.</p> <p>C Clean torch.</p> <p>D Replace shielding gas hose.</p> <p>E Disconnect gas hose from the rear of Power Source then raise gas pressure and blow out impurities.</p> <div style="text-align: center;">  <p>WARNING</p> <hr/> <p>1. <i>Wear approved face shield or safety goggles.</i></p> <p><i>Side shields recommended.</i></p> <p>2. <i>Wear proper body protection to protect skin.</i></p> <hr/> </div> <p>F Turn On Shielding Gas and adjust Shielding Gas flow rate for the welding job. Refer to Table 5-5 on Page 5-7.</p> <p>G Increase electrode diameter or reduce the welding current.</p> |

| FAULT | CAUSE | REMEDY |
|-------------------------------------|--|---|
| 7 Dirty weld pool | <p>A Electrode contaminated by contact with work piece or filler rod material.</p> <p>B Work piece surface has foreign material on it.</p> <p>C Shielding gas contaminated with air.</p> | <p>A Clean the electrode by grinding off the contaminates.</p> <p>B Clean surface.</p> <p>C Check shielding gas lines for cuts and loose fitting or change shielding gas cylinder.</p> |
| 8 Poor weld finish | Inadequate shielding gas. | Increase shielding gas flow or check shielding gas line for shielding gas flow problems. |
| 9 Arc start is not smooth. | <p>A Tungsten electrode is too large for the welding current.</p> <p>B The wrong electrode is being used for the welding job.</p> <p>C Shielding gas flow rate is too high.</p> <p>D Incorrect shielding gas is being used.</p> <p>E Poor work clamp connection to work piece.</p> | <p>A Select the right size tungsten electrode. Refer to Table 5-1 Cigweld Tungsten Electrode Selection Chart.</p> <p>B Select the right size tungsten electrode type. Refer to Table 5-5 Cigweld Tungsten Electrode Selection Chart.</p> <p>C Select the right shielding gas flow rate for the welding job. Refer to Table 5-5 on page 5-7.</p> <p>D Select the correct shielding gas.</p> <p>E Improve connection to work piece.</p> |
| 10 Arc flutters during TIG welding. | Tungsten electrode is too large for the welding current. | Select the right size tungsten electrode. Refer to Table 5-1 Tungsten Electrode Current Ranges. |

Table 5-6: GTAW (TIG) Welding Problems

This Page Intentionally Blank

SECTION 6: STICK (MMAW) WELDING

6.01 Setup For STICK (MMAW) Welding

- Select Stick mode with the process selection control (refer to Section 4.02.4 for further information).
- Connect the Electrode Holder lead to the positive welding terminal (+). If in doubt, consult the electrode manufacturer. Welding current flows from the Power Source via Dinse terminals. It is essential, however, that the male plug is inserted and turned securely to achieve a sound electrical connection.
- Connect the work lead to the negative welding terminal (-). If in doubt, consult the electrode manufacturer. Welding current flows from the power source via Dinse terminals. It is essential, however, that the male plug is inserted and turned securely to achieve a sound electrical connection.

**WARNING**

Before connecting the work clamp to the work and inserting the electrode in the electrode holder make sure the Mains power supply is switched off.

**CAUTION**

Remove any packaging material prior to use. Do not block the air vents at the front or rear of the Welding Power Source.

**CAUTION**

Loose welding terminal connections can cause overheating and result in the male plug being fused in the terminal

NOTE

Consult the electrode manufacturer's information for the correct polarity.

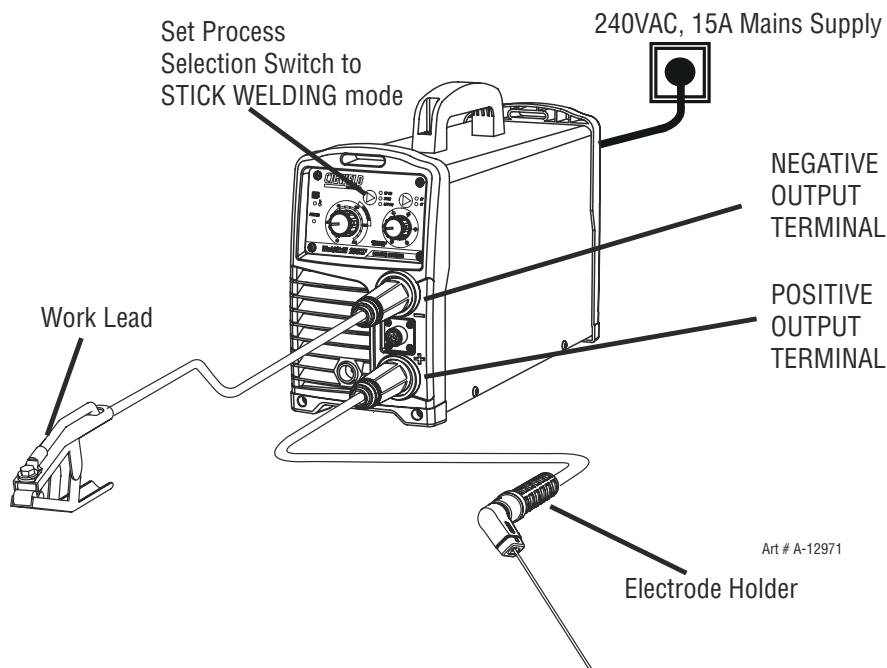

Figure 6-1: Setup For STICK (MMAW) Welding

6.02 Arc Welding Electrodes

Metal arc welding electrodes consist of a core wire surrounded by a flux coating. The flux coating is applied to the core wire by an extrusion process.

The coating on arc welding electrodes serves a number of purposes:

- A. To provide a gaseous shield for the weld metal, and preserve it from contamination by the atmosphere whilst in a molten state.
- B. To give a steady arc by having 'arc stabilisers' present, which provide a bridge for current to flow across.
- C. To remove oxygen from the weld metal with 'deoxidisers'.
- D. To provide a cleansing action on the work piece and a protective slag cover over the weld metal to prevent the formation of oxides while the metal is solidifying. The slag also helps to produce a bead of the desired contour.
- E. To introduce alloys into the weld deposits in special type electrodes.

6.03 Types of Electrodes

Arc Welding electrodes are classified into a number of groups depending on their applications. There are a great number of electrodes used for specialised industrial purposes which are not of particular interest for everyday general work. These include some low hydrogen types for high tensile steel, cellulose types for welding large diameter pipes, etc.

The range of electrodes dealt with in this publication will cover the vast majority of applications likely to be encountered; are all easy to use and all will work on even the most basic of welding machines.

| CIGWELD Electrode Selection Chart | | | | |
|-----------------------------------|----------|--------|----------|--|
| Description | Diameter | Pack | Part No. | Application |
| Saticraft 13 | 2.5mm | 1kg | 322135 | General purpose electrode suitable for all positional welding and galvanised steel. |
| | 2.5mm | 2.5kg | 612182 | |
| | 3.2mm | 1kg | 322136 | |
| | 3.2mm | 2.5kg | 612183 | |
| | 4.0mm | 5kg | 611184 | |
| Ferrocraft 12XP | 2.0mm | 1kg | 322128 | General purpose, extra performance electrode recommended for all positional (inc. Vertical down) welding of mild and galvanised steel. |
| | 2.0mm | 2.5kg | 612231 | |
| | 2.5mm | 1kg | 322129 | |
| | 2.5mm | 2.5kg | 612232 | |
| | 3.2mm | 1kg | 322138 | |
| | 3.2mm | 2.5kg | 612233 | |
| WeldSkill GP | 2.0mm | 1 kg | WEG1020 | User-friendly GP electrode for welding thin section mild and galvanised steels. Excellent for vertical down fillet welding applications. |
| | 2.0mm | 2.5 kg | WEG2520 | |
| | 2.5mm | 1 kg | WEG1025 | |
| | 2.5mm | 2.5 kg | WEG2525 | |
| | 2.5mm | 5 kg | WEG5025 | |
| | 3.2mm | 1 kg | WEG1032 | |
| | 3.2mm | 2.5 kg | WEG2532 | |
| | 3.2mm | 5 kg | WEG5032 | |
| | 4.0mm | 5 kg | WEG5040 | |
| Ferrocraft 16 Twincoat | 2.5mm | 5 kg | 611752 | Hydrogen Controlled type offering exceptional AC/DC performance in all welding positions. |
| | 3.2mm | 5 kg | 611753 | |
| | 4.0mm | 5 kg | 611754 | |
| Saticrome 308L-17 | 2.5mm | 2.5 kg | 611602 | Stainless Steel type for 19Cr/10Ni stainless grades including 201, 202, 301, 302, 303, 304, 304L, 305, 308, etc |
| | 3.2mm | 2.5 kg | 611603 | |
| | 4.0mm | 2.5 kg | 611604 | |

Cigweld Electrode Selection Chart continued over page

| CIGWELD Electrode Selection Chart cont'd | | | | |
|--|-------------|-------------|----------|---|
| Description | Diameter | Pack | Part No. | Application |
| Satinchrome 309Mo-17 | 2.5mm | 2.5 kg | 611692 | Stainless Steel type for 309 and 309L grades. It is also suitable for welding of dissimilar welding of other 300 series stainless steels. |
| | 3.2mm | 2.5 kg | 611693 | |
| | 4.0mm | 2.5 kg | 611694 | |
| Satinchrome 316L-17 | 2.0mm | 2,5 kg | 611661 | Stainless Steel type for welding of matching Mo bearing grades, 316 and 316L. |
| | 2.5mm | 2.5 kg | 611662 | |
| | 3.2mm | 2.5 kg | 611663 | |
| | 2.5/3.2mm | Blisterpack | 322215 | |
| Weldall | 2.5mm | 2.5 kg | 611702 | High alloy stainless steel type for welding of unknown steels, repair of die or tool steels and for joining dissimilar steels. (Not recommended for cast iron). |
| | 3.2mm | 2.5 kg | 611703 | |
| | 2.5/3.2mm | Blisterpack | 322216 | |
| | 4.0mm | 2.5 kg | 611704 | |
| Castcraft 55 | 3.2mm | 2.5 kg | 611723 | For repair and maintenance welding of S.G. cast iron, meehanite and other cast irons. It produces a higher strength weld than Castcraft 100. |
| Castcraft 100 | 2.5mm | 2.5 kg | 611732 | Soft, Ductile Nickel type electrode for repair and maintenance welding of a wide range of cast irons. It has better "wetting" action than Castcraft 55. |
| | 3.2mm | 2.5 kg | 611733 | |
| | Blisterpack | Blisterpack | 322217 | |
| | 4.0mm | 2.5 kg | 611734 | |

Table 6-1 Types of Electrodes

6.04 Size of Electrode

The electrode size is determined by the thickness of metals being joined and can also be governed by the type of welding machine available. Small welding machines will only provide sufficient current (amperage) to run the smaller size electrodes.

For most work, a 2.5mm electrode will be quite sufficient. A 2.5mm electrode will give just as strong a joint but may require a few more weld runs to be put down to fill the joint.

For thin sections, it is necessary to use smaller electrodes otherwise the arc may burn holes through the job. A little practice will soon establish the most suitable electrode for a given application.

6.05 Storage of Electrodes

Always store electrodes in a dry place and in their original containers.

6.06 Electrode Polarity

Electrodes are connected to the Electrode Holder, and the Work Lead is connected to the work piece. Consult the Electrode manufacturer's information for the correct polarity.

6.07 Effects of Arc Welding Various Materials

A. High tensile and alloy steels

The two most prominent effects of welding these steels are the formation of a hardened zone in the weld area, and, if suitable precautions are not taken, the occurrence in this zone of under-bead cracks may result. Hardened zone and under-bead cracks in the weld area may be reduced by using the correct electrodes, preheating, using higher current settings, using larger electrode sizes, short runs for larger electrode deposits or tempering in a furnace.

B. Austenitic manganese steels

The effect on manganese steel of slow cooling from high temperatures is to embrittle it. For this reason it is absolutely essential to keep manganese steel cool during welding by quenching after each weld or skip welding to distribute the heat.

C. Cast Iron

Most types of cast iron, except white iron, are weldable. White iron, because of its extreme brittleness, generally cracks when attempts are made to weld it. Trouble may also be experienced when welding white-heart malleable, due to the porosity caused by gas held in this type of iron.

D. Copper and alloys

The most important factor is the high rate of heat conductivity of copper, making preheating of heavy sections necessary to give proper fusion of weld and base metal.

6.08 Arc Welding Practice

The techniques used for arc welding are almost identical regardless of what types of metals are being joined. Naturally enough, different types of electrodes would be used for different metals as described in the preceding section.

6.09 Welding Position

The electrodes dealt with in this publication can be used in most positions, i.e. they are suitable for welding in flat, horizontal, vertical and overhead positions. Numerous applications call for welds to be made in positions intermediate between these. Some of the common types of welds are shown in Figures 6-2 through 6-9.

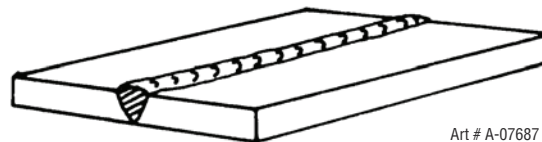

Art # A-07687

Figure 6-2: Flat position, down hand butt weld

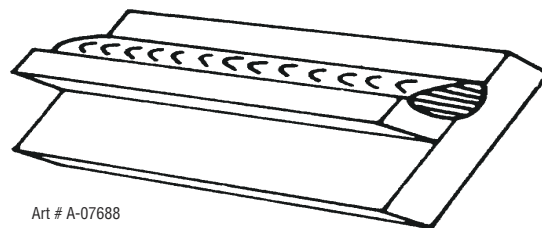

Art # A-07688

Figure 6-3: Flat position, gravity fillet weld

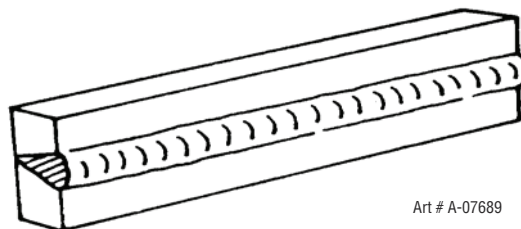

Art # A-07689

Figure 6-4: Horizontal position, butt weld

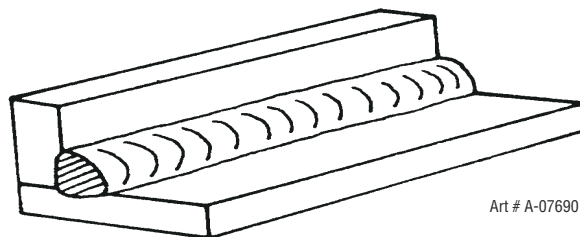

Art # A-07690

Figure 6-5: Horizontal - Vertical (HV) position

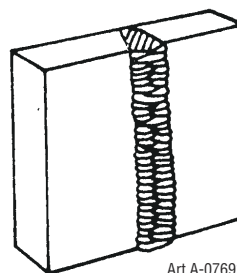

Art A-07691

Figure 6-6: Vertical position, butt weld

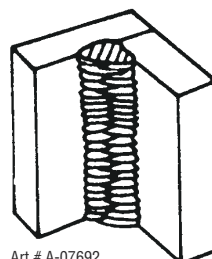

Art # A-07692

Figure 6-7: Vertical position, fillet weld

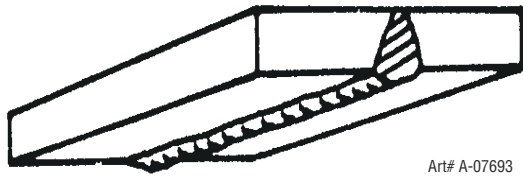

Art# A-07693

Figure 6-8: Overhead position, butt weld

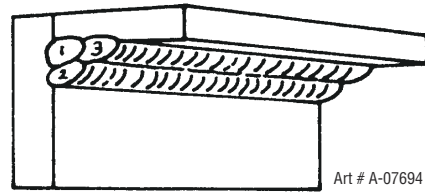

Art # A-07694

Figure 6-9: Overhead position fillet, weld

6.10 Joint Preparations

In many cases, it will be possible to weld steel sections without any special preparation. For heavier sections and for repair work on castings, etc., it will be necessary to cut or grind an angle between the pieces being joined to ensure proper penetration of the weld metal and to produce sound joints.

In general, surfaces being welded should be clean and free of rust, scale, dirt, grease, etc. Slag should be removed from oxy-cut surfaces. Typical joint designs are shown in Figure 6-10.

Open Square Butt Joint

Gap varies from 1.6mm (1/16") to 4.8mm (3/16") depending on plate thickness

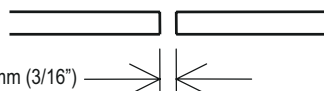

Single Vee Butt Joint

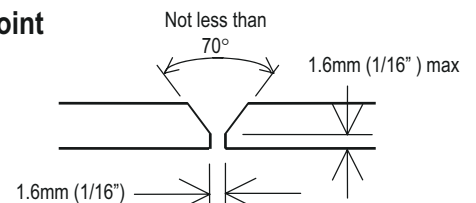

Single Vee Butt Joint

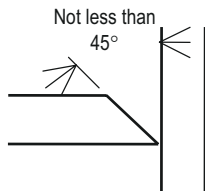

Double Vee Butt Joint

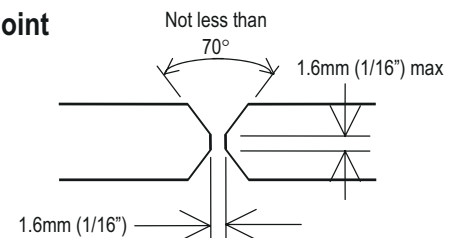

Lap Joint



Fillet Joint

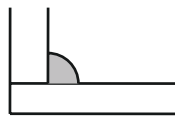

Tee Joints (Fillet both sides of the joint)

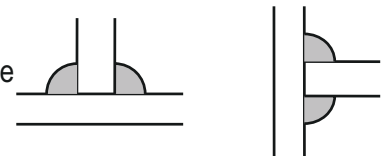

Corner Weld

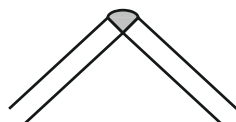

Edge Joint

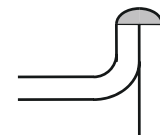

Plug Weld

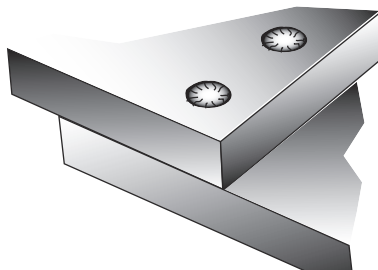

Art # A-07695_AE

Plug Weld

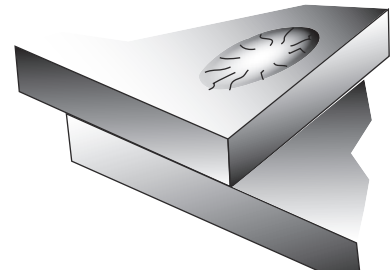

Figure 6-10: Typical joint designs for arc welding

6.11 Arc Welding Technique

A Word to Beginners

For those who have not yet done any welding, the simplest way to commence is to run beads on a piece of scrap plate. Use mild steel plate about 6.0mm thick and a 3.2mm electrode. Clean any paint, loose scale or grease off the plate and set it firmly on the work bench so that welding can be carried out in the downhand position. Make sure that the work clamp is making good electrical contact with the work, either directly or through the work table. For light gauge material, always clamp the work lead directly to the job, otherwise a poor circuit will probably result.

6.12 The Welder

Place yourself in a comfortable position before beginning to weld. Get a seat of suitable height and do as much work as possible sitting down. Don't hold your body tense. A taut attitude of mind and a tensed body will soon make you feel tired. Relax and you will find that the job becomes much easier. You can add much to your peace of mind by wearing a leather apron and gauntlets. You won't be worrying then about being burnt or sparks setting alight to your clothes.

Place the work so that the direction of welding is across, rather than to or from, your body. The electrode holder lead should be clear of any obstruction so that you can move your arm freely along as the electrode burns down. If the lead is slung over your shoulder, it allows greater freedom of movement and takes a lot of weight off your hand. Be sure the insulation on your cable and electrode holder is not faulty, otherwise you are risking an electric shock.

6.13 Striking the Arc

Practice this on a piece of scrap plate before going on to more exacting work. You may at first experience difficulty due to the tip of the electrode "sticking" to the work piece. This is caused by making too heavy a contact with the work and failing to withdraw the electrode quickly enough. A low amperage will accentuate it. This freezing-on of the tip may be overcome by scratching the electrode along the plate surface in the same way as a match is struck. As soon as the arc is established, maintain a 1.6mm to 3.2mm gap between the burning electrode end and the parent metal. Draw the electrode slowly along as it melts down.

Another difficulty you may meet is the tendency, after the arc is struck, to withdraw the electrode so far that the arc is broken again. A little practice will soon remedy both of these faults.

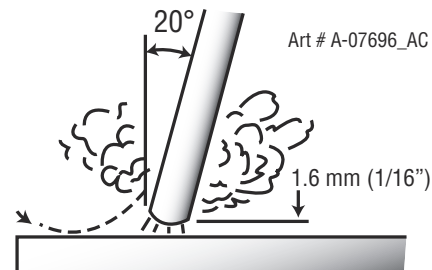

Figure 6-11: Striking an arc

6.14 Arc Length

The securing of an arc length necessary to produce a neat weld soon becomes almost automatic. You will find that a long arc produces more heat. A very long arc produces a crackling or spluttering noise and the weld metal comes across in large, irregular blobs. The weld bead is flattened and spatter increases. A short arc is essential if a high quality weld is to be obtained although if it is too short there is the danger of it being blanketed by slag and the electrode tip being solidified in. If this should happen, give the electrode a quick twist back over the weld to detach it. Contact or "touch-weld" electrodes such as Ferrocrafter 21 do not stick in this way, and make welding much easier.

6.15 Rate of Travel

After the arc is struck, your next concern is to maintain it, and this requires moving the electrode tip towards the molten pool at the same rate as it is melting away. At the same time, the electrode has to move along the plate to form a bead. The electrode is directed at the weld pool at about 20° from the vertical. The rate of travel has to be adjusted so that a well-formed bead is produced.

If the travel is too fast, the bead will be narrow and strung out and may even be broken up into individual globules. If the travel is too slow, the weld metal piles up and the bead will be too large.

6.16 Making Welded Joints

Having attained some skill in the handling of an electrode, you will be ready to go on to make up welded joints.

NOTE

The welding current range values should be used as a guide only. Current delivered to the arc is dependent on the welding arc voltage, and as welding arc voltage varies between different classes of electrode, welding current at any one setting would vary according to the type of electrode in use. The operator should use the welding current range values as a guide, then

finally adjust the current setting to suit the application.

A. Butt Welds

Set up two plates with their edges parallel, as shown in Figure 6-12, allowing 1.6mm to 2.4mm gap between them and tack weld at both ends. This is to prevent contraction stresses from the cooling weld metal pulling the plates out of alignment. Plates thicker than 6.0mm should have their mating edges bevelled to form a 70° to 90° included angle. This allows full penetration of the weld metal to the root. Using a 3.2mm Ferrocrafter 21 electrode at 100 amps, deposit a run of weld metal on the bottom of the joint.

Do not weave the electrode, but maintain a steady rate of travel along the joint sufficient to produce a well-formed bead. At first you may notice a tendency for undercut to form, but keeping the arc length short, the angle of the electrode at about 20° from vertical, and the rate of travel not too fast, will help eliminate this. The electrode needs to be moved along fast enough to prevent the slag pool from getting ahead of the arc. To complete the joint in thin plate, turn the job over, clean the slag out of the back and deposit a similar weld.

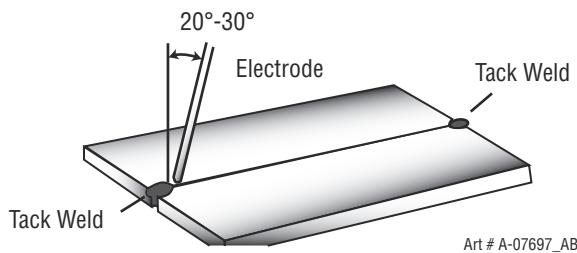

Figure 6-12: Butt weld

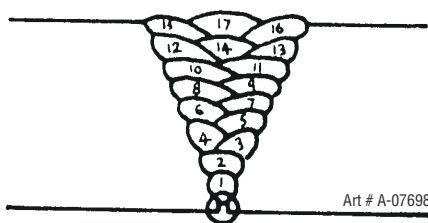

Figure 6-13: Weld build up sequence

Heavy plate will require several runs to complete the joint. After completing the first run, chip the slag out and clean the weld with a wire brush. It is important to do this to prevent slag being trapped by the second run. Subsequent runs are then deposited using either a weave technique or single beads laid down in the sequence shown in Figure 6-13. The width of weave should not be more than three times the core wire diameter of the electrode. When the joint is completely filled, the back is either machined, ground or gouged out to remove slag which may be trapped in the root, and to prepare a suitable joint for depositing the backing run. If a backing bar is used, it is not usually

necessary to remove this, since it serves a similar purpose to the backing run in securing proper fusion at the root of the weld.

B. Fillet Welds

These are welds of approximately triangular cross-section made by depositing metal in the corner of two faces meeting at right angles. Refer to Figure 6-5.

A piece of angle iron is a suitable specimen with which to begin, or two lengths of strip steel may be tacked together at right angles. Using a 3.2mm Ferrocrafter 21 electrode at 100 amps, position angle iron with one leg horizontal and the other vertical. This is known as a horizontal-vertical (HV) fillet. Strike the arc and immediately bring the electrode to a position perpendicular to the line of the fillet and about 45° from the vertical. Some electrodes require to be sloped about 20° away from the perpendicular position to prevent slag from running ahead of the weld. Refer to Figure 6-14. Do not attempt to build up much larger than 6.4mm width with a 3.2mm electrode, otherwise the weld metal tends to sag towards the base, and undercut forms on the vertical leg. Multi-runs can be made as shown in Figure 6-15. Weaving in HV fillet welds is undesirable.

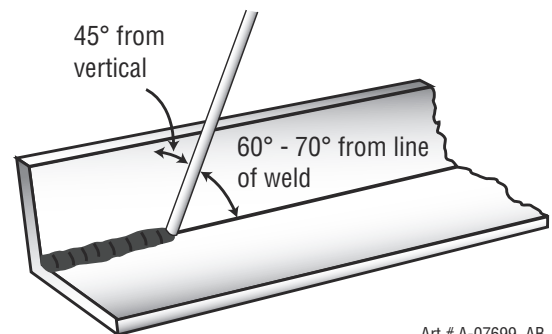

Figure 6-14: Electrode position for HV fillet weld

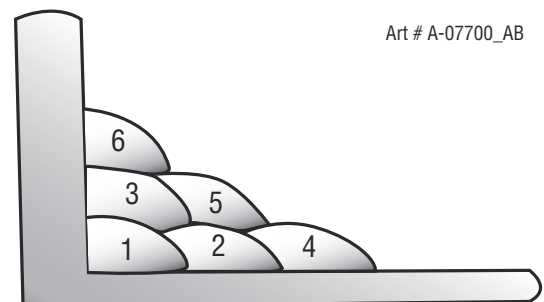

Figure 6-15: Multi-runs in HV fillet weld

C. Vertical Welds

1. Vertical Up

Tack weld a three feet length of angle iron to your work bench in an upright position. Use a 3.2mm Ferrocrafft 21 electrode and set the current at 100 amps. Make yourself comfortable on a seat in front of the job and strike the arc in the corner of the fillet. The electrode needs to be about 10° from the horizontal to enable a good bead to be deposited. Refer Figure 6-16. Use a short arc, and do not attempt to weave on the first run. When the first run has been completed de-slag the weld deposit and begin the second run at the bottom. This time a slight weaving motion is necessary to cover the first run and obtain good fusion at the edges. At the completion of each side motion, pause for a moment to allow weld metal to build up at the edges, otherwise undercut will form and too much metal will accumulate in the centre of the weld. Figure 6-17 illustrates multi-run technique and Figure 6-18 shows the effects of pausing at the edge of weave and of weaving too rapidly.

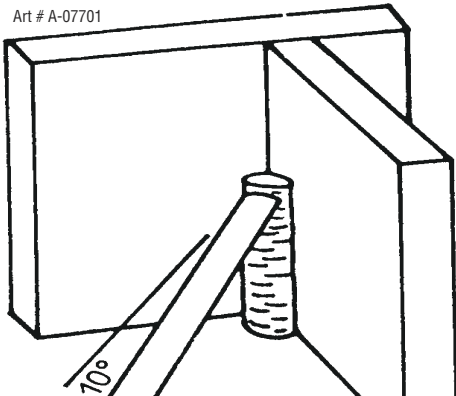

Figure 6-16: Single run vertical fillet weld

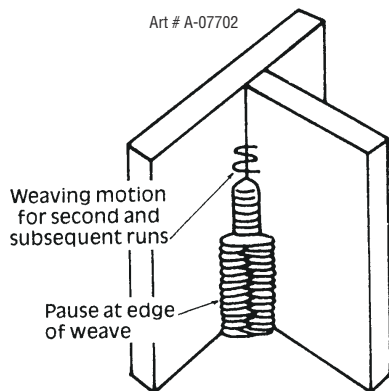
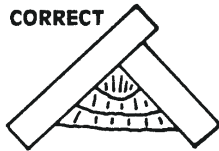
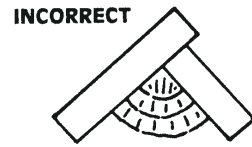

Figure 6-17: Multi run vertical fillet weld



CORRECT
Pause at edge of weave allows weld metal to build up, and eliminates undercut



INCORRECT
Note weld contour when insufficient pause at edge of weave

Art # A-07703

Figure 6-18: Examples of vertical fillet welds

2. Vertical Down

The Ferrocrafft 21 electrode makes welding in this position particularly easy. Use a 3.2mm electrode at 100 amps. The tip of the electrode is held in light contact with the work and the speed of downward travel is regulated so that the tip of the electrode just keeps ahead of the slag. The electrode should point upwards at an angle of about 45°.

3. Overhead Welds

Apart from the rather awkward position necessary, overhead welding is not much more difficult than downhand welding. Set up a specimen for overhead welding by first tacking a length of angle iron at right angles to another piece of angle iron or a length of waste pipe. Then tack this to the work bench or hold in a vice so that the specimen is positioned in the overhead position as shown in the sketch. The electrode is held at 45° to the horizontal and tilted 10° in the line of travel (Figure 6-19). The tip of the electrode may be touched lightly on the metal, which helps to give a steady run. A weave technique is not advisable for overhead fillet welds. Use a 3.2mm Ferrocrafft 12XP electrode at 100 amps, and deposit the first run by simply drawing the electrode along at a steady rate. You will notice that the weld deposit is rather convex, due to the effect of gravity before the metal freezes.

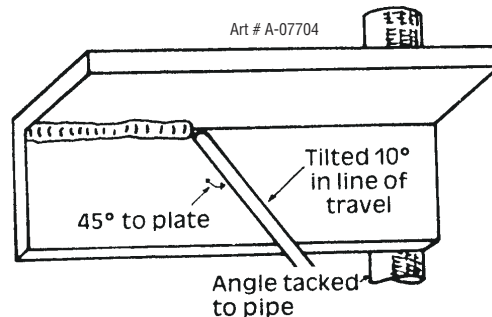

Figure 6-19: Overhead fillet weld

6.17 Distortion

Distortion in some degree is present in all forms of welding. In many cases it is so small that it is barely perceptible, but in other cases allowance has to be made before welding commences for the distortion that will subsequently occur. The study of distortion is so complex that only a brief outline can be attempted here.

6.18 The Cause of Distortion

Distortion is caused by:

A. Contraction of Weld Metal:

Molten steel shrinks approximately 11 per cent in volume on cooling to room temperature. This means that a cube of molten metal would contract approximately 2.2 per cent in each of its three dimensions. In a welded joint, the metal becomes attached to the side of the joint and cannot contract freely. Therefore, cooling causes the weld metal to flow plastically, that is, the weld itself has to stretch if it is to overcome the effect of shrinking volume and still be attached to the edge of the joint. If the restraint is very great, as, for example, in a heavy section of plate, the weld metal may crack. Even in cases where the weld metal does not crack, there will still remain stresses “locked-up” in the structure. If the joint material is relatively weak, for example, a butt joint in 2.0mm sheet, the contracting weld metal may cause the sheet to become distorted.

B. Expansion and Contraction of Parent Metal in the Fusion Zone:

While welding is proceeding, a relatively small volume of the adjacent plate material is heated to a very high temperature and attempts to expand in all directions. It is able to do this freely at right angles to the surface of the plate (i.e., “through the weld”), but when it attempts to expand “across the weld” or “along the weld”, it meets considerable resistance, and to fulfil the desire for continued expansion, it has to deform plastically, that is, the metal adjacent to the weld is at a high temperature and hence rather soft, and, by expanding, pushes against the cooler, harder metal further away, and tends to bulge (or is “upset”). When the weld area begins to cool, the “upset” metal attempts to contract as much as it expanded, but, because it has been “upset”, it does not resume its former shape, and the contraction of the new shape exerts a strong pull on adjacent metal. Several things can then happen.

The metal in the weld area is stretched (plastic deformation), the job may be pulled out of shape by the powerful contraction stresses (distortion), or the weld may crack, in any case, there will remain

“locked-up” stresses in the job. Figures 6-20 and 6-21 illustrate how distortion is created.

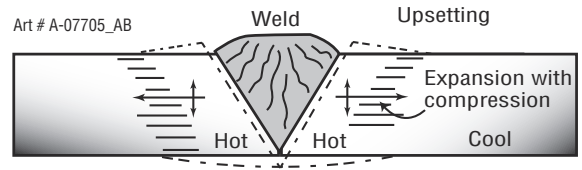

Figure 6-20: Parent metal expansion

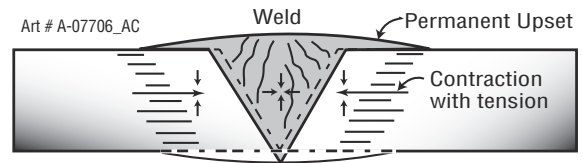

Figure 6-21: Parent metal contraction

6.19 Overcoming Distortion Effects

There are several methods of minimising distortion effects.

A. Peening

This is done by hammering the weld while it is still hot. The weld metal is flattened slightly and because of this the tensile stresses are reduced a little. The effect of peening is relatively shallow, and is not advisable on the last layer.

B. Distribution of Stresses

Distortion may be reduced by selecting a welding sequence which will distribute the stresses suitably so that they tend to cancel each other out. See Figures 6-25 through 6-28 for various weld sequences. Choice of a suitable weld sequence is probably the most effective method of overcoming distortion, although an unsuitable sequence may exaggerate it. Simultaneous welding of both sides of a joint by two welders is often successful in eliminating distortion.

C. Restraint of Parts

Forcible restraint of the components being welded is often used to prevent distortion. Jigs, positions, and tack welds are methods employed with this in view.

D. Presetting

It is possible in some cases to tell from past experience or to find by trial and error (or less frequently, to calculate) how much distortion will take place in a given welded structure. By correct pre-setting of the components to be welded, constructional stresses can be made to pull the parts into correct alignment. A simple example is shown in Figure 6-22.

E. Preheating

Suitable preheating of parts of the structure other than the area to be welded can be sometimes used to reduce distortion. Figure 6-23 shows a simple application. By removing the heating source from b and c as soon as welding is completed, the sections b and c will contract at a similar rate, thus reducing distortion.

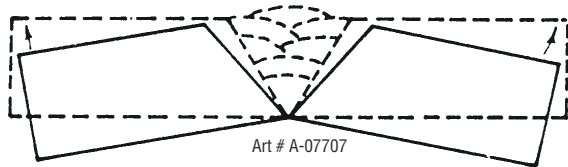

Art # A-07707

Figure 6-22: Principle of presetting

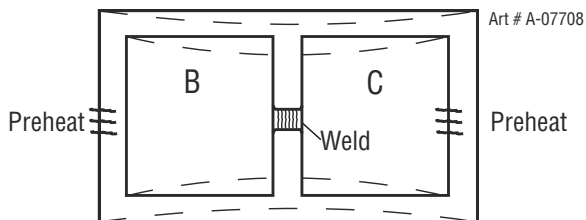

Dotted lines show effect if no preheat is used

Figure 6-23: Reduction of distortion by preheating

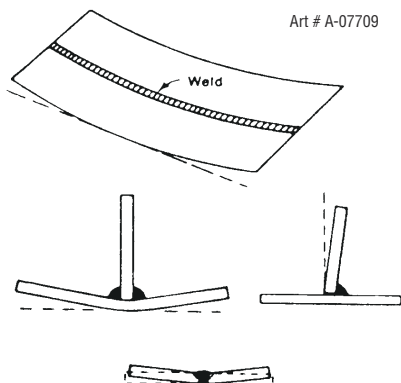

Art # A-07709

Figure 6-24: Examples of distortion

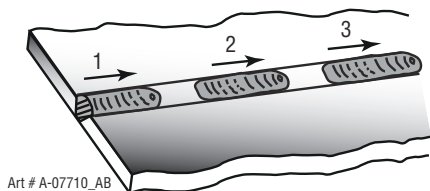

Art # A-07710_AB

Block Sequence.
The spaces between the welds are filled in when the welds are cool.

Figure 6-25: Welding sequence

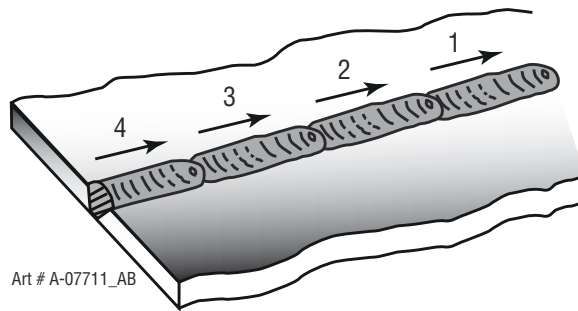

Art # A-07711_AB

Figure 6-26: Step back sequence

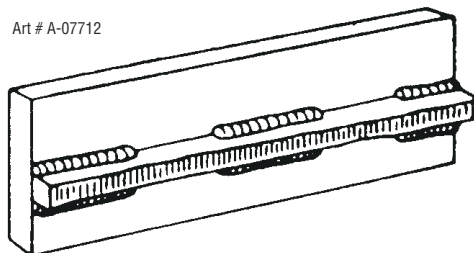

Art # A-07712

Figure 6-27: Chain intermittent welding

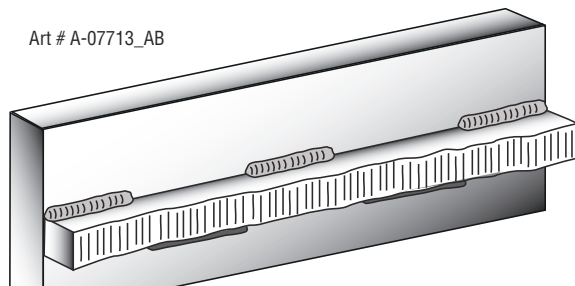

Art # A-07713_AB

Figure 6-28: Staggered intermittent welding

6.20 Welding Problems

| Description | Possible Cause | Remedy |
|---|--|---|
| 1 Gas pockets or voids in weld metal (Porosity) | A Electrodes are damp B Welding current is too high C Surface impurities such as oil, grease, paint, etc | A Dry electrodes before use B Reduce welding current C Clean joint before welding |
| 2 Crack occurring in weld metal soon after solidification commences | A Rigidity of joint B Insufficient throat thickness C Cooling rate is too high | A Redesign to relieve weld joint of severe stresses or use crack resistance electrodes B Travel slightly slower to allow greater build-up in throat C Preheat plate and cool slowly |
| 3 A gap is left by failure of the weld metal to fill the root of the weld | A Welding current is too low B Electrode too large for joint C Insufficient gap D Incorrect sequence | A Increase welding current B Use smaller diameter electrode C Allow wider gap D Use correct build-up sequence |

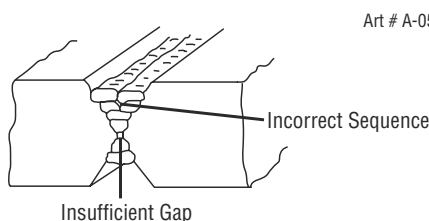

Figure 6-29: Example of Insufficient Gap or Incorrect Sequence

| | | |
|---|---|---|
| 4 Portions of the weld run do not fuse to the surface of the metal or edge of the joint | A Small electrodes used on heavy cold plate B Welding current is too low C Wrong electrode angle D Travel speed of electrode is too high E Scale or dirt on joint surface | A Use larger electrodes and preheat the plate B Increase welding current C Adjust angle so the welding arc is directed more into the base metal D Reduce travel speed of electrode E Clean surface before welding |
|---|---|---|

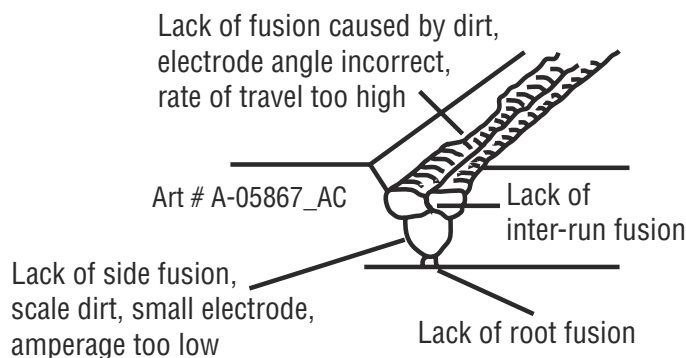

Figure 6-30: Example of Lack of Fusion

| Description | Possible Cause | Remedy |
|--|---|---|
| 5 A groove has been formed in the base metal adjacent to the toe of a weld and has not been filled by the weld metal (undercut). | A Welding current is too high. | A Reduce welding current |
| | B Welding arc is too long. | B Reduce the length of the welding arc |
| | C Angle of the electrode is incorrect. | C Electrode should not be inclined less than 45° to the vertical face |
| | D Joint preparation does not allow correct electrode angle. | D Allow more room in joint for manipulation of the electrode. |
| | E Electrode too large for joint. | E Use smaller gauge electrode. |
| | F Insufficient deposit time at edge of weave. | F Pause for a moment at edge of weave to allow weld metal build-up. |

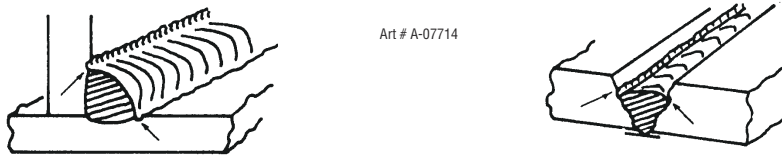

Figure 6-31: Examples of undercut

| | | |
|---|---|--|
| 6 Non-metallic particles are trapped in the weld metal (slag inclusion) | A Non-metallic particles may be trapped in undercut from previous run | A If bad undercut is present, clean slag out and cover with a run from a smaller diameter electrode |
| | B Joint preparation too restricted | B Allow for adequate penetration and room for cleaning out the slag |
| | C Irregular deposits allow slag to be trapped | C If very bad, chip or grind out irregularities |
| | D Lack of penetration with slag trapped beneath weld bead | D Use smaller electrode with sufficient current to give adequate penetration. Use suitable tools to remove all slag from corners |
| | E Rust or mill scale is preventing full fusion | E Clean joint before welding |
| | F Wrong electrode for position in which welding is done | F Use electrodes designed for position in which welding is done, otherwise proper control of slag is difficult |

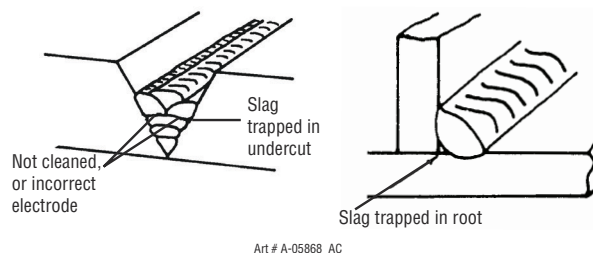

Figure 6-4: Examples of Slag Inclusion

Table 6-2: Welding Problems

SECTION 7: ROUTINE SERVICE REQUIREMENTS AND POWER SOURCE PROBLEMS

7.01 Routine Maintenance & Inspection



WARNING

There are extremely dangerous voltage and power levels present inside this product. Do not attempt to open or repair unless you are a qualified electrical tradesperson. Disconnect the Welding Power Source from the Mains Supply Voltage before disassembling.

Welding equipment should be regularly checked by a qualified electrical tradesperson to ensure that:

- The main earth wire of the electrical installation is intact.
- Power point for the Welding Power Source is effectively earthed and of adequate current rating.
- Plugs and cord extension sockets are correctly wired.
- Flexible cord is of the 3-core tough rubber or plastic sheathed type of adequate rating, correctly connected and in good condition.
- Welding terminals are shrouded to prevent inadvertent contact or short circuit.
- The frame of the Welding Power Source is effectively earthed.
- Welding leads and electrode holder are in good condition.
- The Welding Power Source is clean internally, especially from metal filing, slag, and loose material. If any parts are damaged for any reason, replacement is recommended.

7.02 Cleaning the Welding Power Source



WARNING

There are extremely dangerous voltage and power levels present inside this product. Do not attempt to open or repair unless you are a qualified electrical tradesperson. Disconnect the Welding Power Source from the Mains Supply Voltage before disassembling.

To clean the Welding Power Source, open the enclosure and use a vacuum cleaner to remove any accumulated dirt, metal filings, slag and loose material. Keep the shunt and lead screw surfaces clean as accumulated foreign material may reduce the welders output welding current.



CAUTION

Do not use compressed air to clean the Welding Power Source. Compressed air can force metal particles to lodge between live electrical parts and earthed metal parts within the Welding Power Source. This may result in arcing between these parts and their eventual failure.

7.03 Basic Troubleshooting



WARNING

There are extremely dangerous voltage and power levels present inside this product. Do not attempt to open or repair unless you are a qualified electrical tradesperson and you have had training in power measurements and troubleshooting techniques.

If major complex subassemblies are faulty, then the Welding Power Source must be returned to an Accredited CIGWELD Service Provider for repair.

The basic level of troubleshooting is that which can be performed without special equipment or knowledge.

7.04 Power Source Problems

| Description | Possible Cause | Remedy |
|--|--|---|
| 1 Mains Supply Voltage is On, the On/Off switch on the rear panel is in the On position and the Power indicator on the front panel is illuminated however the power source will not STICK weld. | <p>A Power Source is not in the correct mode of operation.</p> <p>B Work Lead is not connected to the work piece.</p> | <p>A Set the power source to STICK mode.</p> <p>B Ensure that the Work Lead is connected to the work piece and has a good connection to the work piece.</p> |
| 2 Mains Supply Voltage is On, the On/Off switch on the rear panel is in the On position and the Power indicator on the front panel is illuminated however the power source will not commence welding in TIG modes. | <p>A Power Source is not in the correct mode of operation.</p> <p>B Work Lead is not connected to the work piece.</p> <p>C TIG Torch 8 Pin Control Plug not connected correctly or loose/faulty connection in plug.</p> <p>D Faulty TIG Torch Trigger.</p> | <p>A Set the power source to either HF TIG or Lift TIG mode with the process selection control. Refer to section 4.02.4.</p> <p>B Ensure that the Work Lead is connected to the work piece and has a good connection to the work piece.</p> <p>C Connect 8 Pin TIG Torch control plug securely and correctly to the 8 Pin control socket of the front of the WeldSkill 200HF Power Source. Repair or replace if faulty.</p> <p>D Repair or replace TIG Torch Trigger switch/lead.</p> |
| 3 Over Temp Indicator is illuminated and unit will not commence welding. | Duty cycle of power source has been exceeded. | Leave the power source switched ON and allow it to cool. Note that Over Temp indicator must be extinguished prior to commencement of welding. |
| 4 The welding arc cannot be established | <p>A The Mains supply voltage has not been switched ON</p> <p>B The Welding Power Source switch is switched OFF</p> <p>C Loose connections internally</p> | <p>A Switch ON the Mains supply voltage</p> <p>B Switch ON the Welding Power Source</p> <p>C Have an Accredited CIGWELD Service Provider repair the connection</p> |
| 5 Maximum output welding current cannot be achieved with nominal Mains supply voltage | Defective control circuit | Have an Accredited CIGWELD Service Provider inspect then repair the welder |
| 6 Welding current reduces when welding | Poor work lead connection to the work piece | Ensure that the work lead has a positive electrical connection to the work piece |

| Power Source Problems Cont'd | | |
|---|---|--|
| Description | Possible Cause | Remedy |
| 7 No Shielding Gas flow in TIG mode. | A Shielding Gas hose is damaged. | A Replace or repair the Shielding Gas Hose. |
| | B Shielding Gas passage contains impurities. | B Turn Off Shielding Gas supply at cylinder or source and disconnect gas hose from the rear of the power source and blow out impurities. |
| |  WARNING | |
| | <p><i>1. Wear approved face shield or safety goggles.</i></p> <p><i>Side shields recommended.</i></p> <p><i>2. Wear proper body protection to protect skin.</i></p> | |
| | C Shielding Gas Regulator turned Off. | C Turn On the Shielding Gas Regulator and adjust the flow rate to suit the welding job. Refer to Table 5-5 on page 5-7. |
| | D Empty Shielding Gas cylinder. | D Replace Shielding Gas cylinder. |
| 8 Gas flow continues after the torch trigger switch has been released (TIG mode). | E Tig Torch 8 Pin Control Plug is not connected correctly or the Tig Torch Trigger Switch, 8 Pin Control Plug or Lead is faulty. | E Ensure that the 8 Pin Control Plug is correctly connected or repair or replace the Tig Torch Trigger Switch or 8 Pin Control Plug or Lead. |
| | F Shielding Gas Valve in Power Source is not operating correctly. | F Have an Accredited Cigweld service provider repair or replace the Shielding Gas Valve. |
| | A Post flow is active in TIG mode. | A Post Gas Flow time is not adjustable and cannot be adjusted independently of the Welding Current. The Post Flow time range is approximately 1 to 8 seconds depending on the Welding Current Setting. For example if the Welding Current is set to 10 amps the Post Gas Flow time will be approximately 1 second. If the Welding Current is set to 200 Amps the Post Gas Flow time will be approximately 8 seconds. |
| | B Shielding Gas valve has jammed open due to impurities in the gas or the gas line. | B Have an accredited CIGWELD service provider repair or replace shielding gas valve. |

| Power Source Problems Cont'd | | |
|--|---|--|
| Description | Possible Cause | Remedy |
| 9 TIG electrode melts when arc is struck | A TIG torch is connected to the (+) terminal | A Connect the TIG torch to the (-) terminal |
| | B Incorrect Shielding Gas is being used. | B Ensure that Welding Grade Argon is being used. |
| | C Inadequate shielding gas flow or shielding gas not turned on. | C Turn on shielding gas and set shielding gas flow rate for the welding job. Refer to Table 5-5 on Page 5-7. |
| | D Incorrect Tungsten | D Check Tungsten type and size and change if necessary. |
| 10 Arc flutters during TIG welding | Tungsten electrode is too large for the welding current | Select the correct size of tungsten electrode refer to Table 5-1 Cigweld Tungsten Electrode Selection Chart. |

Table 7-1

SECTION 8: KEY SPARE PARTS

8.01 WeldSkill 200HF Key Spare Parts

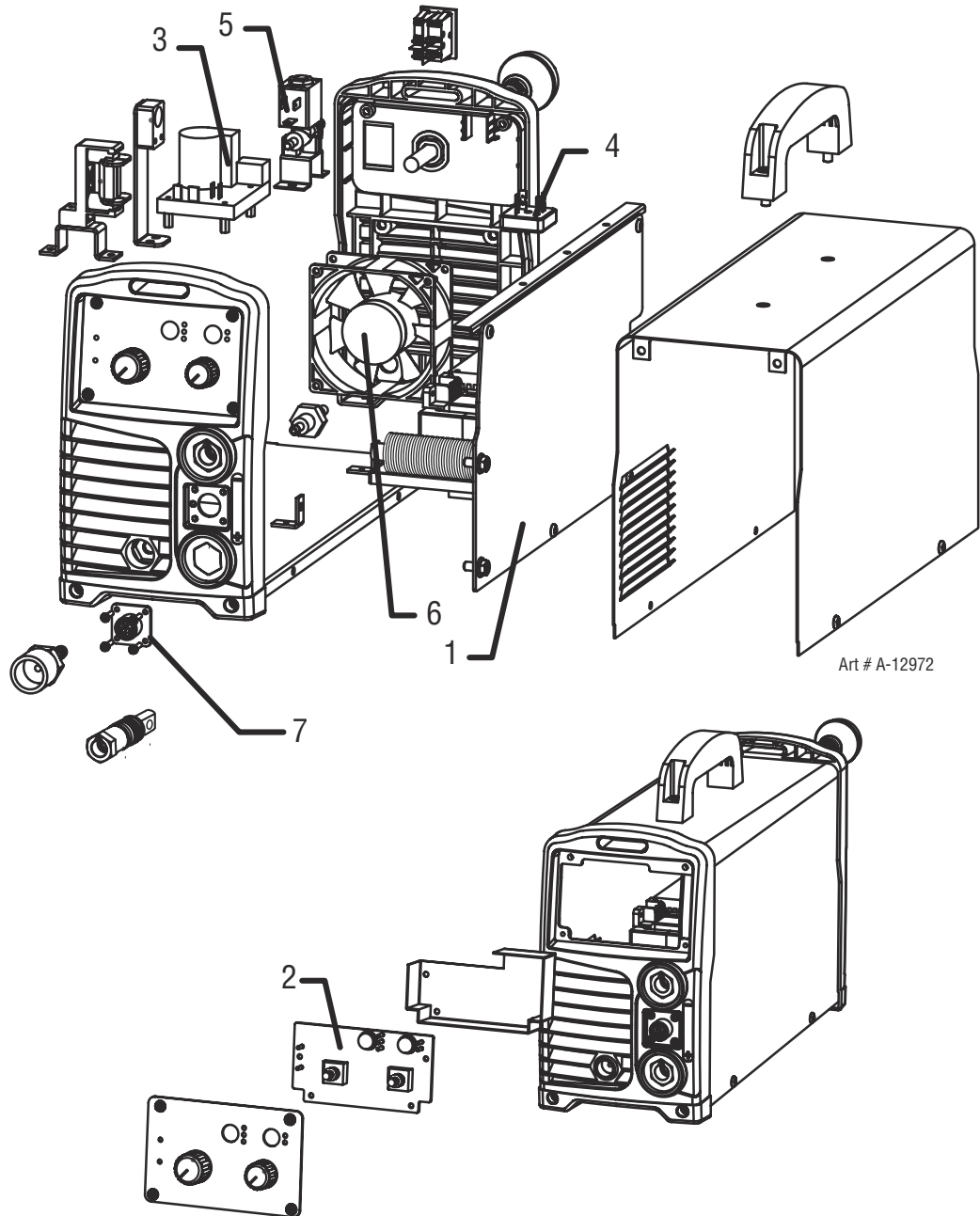

Art # A-12972

Figure 8-1

| WELDSKILL 200HF KEY SPARE PARTS | | |
|---------------------------------|-------------|--|
| ITEM | PART NUMBER | DESCRIPTION |
| 1 | W7006844 | PCB Power Inverter |
| 2 | W7006845 | PCB Front Panel |
| 3 | W7006846 | PCB HF |
| 4 | W7006829 | Primary Rectifier |
| 5 | W7006849 | Solenoid Valve 24VDC |
| 6 | W7006809 | Fan 24VDC |
| 7 | W7006847 | Control Socket 8 Pin c/w wiring harness (Note 8 Pin control plug is part number UOA706900) |

Table 8-1

This Page Intentionally Blank

CIGWELD - LIMITED WARRANTY TERMS

LIMITED WARRANTY: CIGWELD Pty Ltd, An ESAB Brand, hereafter, "CIGWELD" warrants to customers of its authorized distributors hereafter "Purchaser" that its products will be free of defects in workmanship or material. Should any failure to conform to this warranty appear within the time period applicable to the CIGWELD products as stated below, CIGWELD shall, upon notification thereof and substantiation that the product has been stored, installed, operated, and maintained in accordance with CIGWELD's specifications, instructions, recommendations and recognized standard industry practice, and not subject to misuse, repair, neglect, alteration, or accident, correct such defects by suitable repair or replacement, at CIGWELD's sole option, of any components or parts of the product determined by CIGWELD to be defective.

CIGWELD MAKES NO OTHER WARRANTY, EXPRESS OR IMPLIED. THIS WARRANTY IS EXCLUSIVE AND IN LIEU OF ALL OTHERS, INCLUDING, BUT NOT LIMITED TO ANY WARRANTY OF MERCHANTABILITY OR FITNESS FOR ANY PARTICULAR PURPOSE.

LIMITATION OF LIABILITY: CIGWELD SHALL NOT UNDER ANY CIRCUMSTANCES BE LIABLE FOR SPECIAL, INDIRECT OR CONSEQUENTIAL DAMAGES, SUCH AS, BUT NOT LIMITED TO, LOST PROFITS AND BUSINESS INTERRUPTION. The remedies of the Purchaser set forth herein are exclusive and the liability of CIGWELD with respect to any contract, or anything done in connection therewith such as the performance or breach thereof, or from the manufacture, sale, delivery, resale, or use of any goods covered by or furnished by CIGWELD whether arising out of contract, negligence, strict tort, or under any warranty, or otherwise, shall not, except as expressly provided herein, exceed the price of the goods upon which such liability is based. No employee, agent, or representative of CIGWELD is authorized to change this warranty in any way or grant any other warranty.

PURCHASER'S RIGHTS UNDER THIS WARRANTY ARE VOID IF REPLACEMENT PARTS OR ACCESSORIES ARE USED WHICH IN CIGWELD'S SOLE JUDGEMENT MAY IMPAIR THE SAFETY OR PERFORMANCE OF ANY CIGWELD PRODUCT. PURCHASER'S RIGHTS UNDER THIS WARRANTY ARE VOID IF THE PRODUCT IS SOLD TO PURCHASER BY NON-AUTHORIZED PERSONS.

The warranty is effective for the time stated below beginning on the date that the authorized distributor delivers the products to the Purchaser. Notwithstanding the foregoing, in no event shall the warranty period extend more than the time stated plus one year from the date CIGWELD delivered the product to the authorized distributor.

Any claim under this warranty must be made within the warranty period which commences on the date of purchase of the product. To make a claim under the warranty, take the product (with proof of purchase from a Cigweld Accredited Seller) to the store where you purchased the product or contact Cigweld Customer Care 1300 654 674 for advice on your nearest Service Provider. CIGWELD reserves the right to request documented evidence of date of purchase. CIGWELD or our Accredited Distributor must be notified in writing of its claim within seven (7) days of becoming aware of the basis thereof, and at its own expense returning the goods which are the subject of the claim to CIGWELD or nominated Accredited Distributor/Accredited Service Provider

This warranty is given.

Cigweld Pty Ltd

A.B.N. 56007226815

71 Gower Street, Preston

Victoria, Australia, 3072

Phone: 1300 654 674

Email: enquiries@cigweld.com.au

Website: www.cigweld.com.au

This warranty is provided in addition to other rights and remedies you have under law: Our goods come with guarantees which cannot be excluded under the Australian Consumer Law. You are entitled to replacement or refund for a major failure and to compensation for other reasonably foreseeable loss or damage. You are also entitled to have the goods repaired or replaced if the goods fail to be of acceptable quality and the failure does not amount to a major failure.

Please note that the information detailed in this statement supersedes any prior published data produced by CIGWELD.

WARRANTY SCHEDULE – WeldSkill 200HF Inverter

| WARRANTY | WARRANTY PERIOD – (Parts and Labour) |
|--|---|
| WeldSkill 200HF Inverter Power Source | 3 Years |
| Electrode Holder Lead and Work Lead | 3 Months |
| TIG Torch – Part No. W4014604 | 3 Months |
| TIG Torch Consumables | Nil |
| WeldSkill Argon Regulator – Part No. 210254 (Excluding seat assembly, pressure gauges, elastomer seals and “O” rings) | 1 Year |
| Regulator seat assemblies and pressure gauges | 6 Months |
| Elastomer seals and “O” rings used in the equipment | 3 Months |

CIGWELD Limited Warranty does not apply to;

- Obsolete goods sold at auction, second-hand goods and prototype goods.
- Consumable Parts for MIG, TIG, Plasma welding, Plasma cutting and Oxy fuel torches, O-rings, fuses, filters or other parts that fail due to normal wear.

Note:

* No employee, agent, or representative of CIGWELD is authorized to change this warranty in any way or grant any other warranty, and CIGWELD shall not be bound by any such attempt. Correction of non-conformities, in the manner and time provided herein, constitutes fulfilment of CIGWELD's obligations to purchaser with respect to the product.

* This warranty is void, and seller bears no liability hereunder, if purchaser used replacement parts or accessories which, in CIGWELD's sole judgment, impaired the safety or performance of any CIGWELD product and if the unit is altered or serviced by an unauthorised CIGWELD Service Provider. Purchaser's rights under this warranty are void if the product is sold to purchaser by unauthorized persons.

* Warranty voided when the earth pin on the 15A power plug is ground down.

This Page Intentionally Blank



CIGWELD Pty Ltd
CIGWELD An ESAB Brand
71 Gower Street, Preston VIC 3072 Australia

Customer Care:
Tel: 1300 654 674 | Fax: 03 9474 7391
Email: enquiries@cigweld.com.au

International Enquiries
Tel: +61 3 9474 7508 | Fax: +61 3 9474 7488

Malaysia -
Lot 151, Jalan Industri 3/5A
Rawang Integrated Industrial Park,
Jln Batu Arang
48000 Rawang Selangor Darul Ehsan
West Malaysia

Tel: 60 3 6092 2988 | Fax: 60 3 6092 1085

Indonesia -
JL Akasia II Blok A-05 No. 10A
Delta Silicon - Lippo Cikarang
Bekasi, 17550
Indonesia

Toll Free: 0 800 1842 867
Tel: +62 21 8990 6095 | Fax: +62 21 8990 6096