

XCEL-ARC 200 AC/DC PULSE TIG



XA-TIG200RZ ACDC | Operating Manual



Please read and understand this instruction manual carefully before the installation and operation of this equipment.

© Xcel-Arc 2022





CONTENTS



SAFETY.....	4
XCEL-ARC™ TIG200RZ ACDC FEATURES.....	8
MACHINE PARTS LAYOUT.....	9
SELECTOR SWITCH FUNCTIONS.....	10
CONTROL DIAL FUNCTIONS.....	11
INSTALLATION SET UP FOR MMA (STICK) WELDING.....	13
MMA(STICK) WELDING GUIDE.....	15
INSTALLATION SET UP FOR DC TIG WELDING.....	17
TIG WELDING GUIDE.....	19
INSTALLATION SET UP FOR AC TIG WELDING.....	27
AC WELDING GUIDE.....	29
XA26 TIG TORCH & SPARES.....	32
GAS FLOW REGULATORS - SHEILDING GASES	34
MMA (STICK) WELDING TROUBLE SHOOTING.....	35
TIG WELDING TROUBLE SHOOTING.....	36
WARRANTY.....	38
WARRANTY TERMS.....	39
NOTES.....	42



**REGISTER YOUR MACHINE ONLINE TO RECEIVE AN
ADDITIONAL 6 MONTHS ON YOUR WARRANTY**

Visit [XcelArc.nz/warranty-registration/](https://www.XcelArc.nz/warranty-registration/) to register your machine.

Welding and cutting equipment can be dangerous to both the operator and people in or near the surrounding working area, if the equipment is not correctly operated. Equipment must only be used under the strict and comprehensive observance of all relevant safety regulations.

Read and understand this instruction manual carefully before the installation and operation of this equipment.

Machine Operating Safety

- Do not switch the function modes while the machine is operating. Switching of the function modes during welding can damage the machine. Damage caused in this manner will not be covered under warranty.
- Disconnect the electrode-holder cable from the machine before switching on the machine, to avoid arcing should the electrode be in contact with the work piece.
- Operators should be trained and or qualified.



Electric shock: It can kill. Touching live electrical parts can cause fatal shocks or severe burns. The electrode and work circuit is electrically live whenever the output is on. The input power circuit and internal machine circuits are also live when power is on. In MIG/MAG welding, the wire, drive rollers, wire feed housing, and all metal parts touching the welding wire are electrically live. Incorrectly installed or improperly grounded equipment is dangerous.

- Connect the primary input cable according to Australian and New Zealand standards and regulations.
- Avoid all contact with live electrical parts of the welding/cutting circuit, electrodes and wires with bare hands.
- The operator must wear dry welding gloves while he/she performs the welding/cutting task.
- The operator should keep the work piece insulated from himself/herself.
- Keep cords dry, free of oil and grease, and protected from hot metal and sparks.
- Frequently inspect input power cable for wear and tear, replace the cable immediately if damaged, bare wiring is dangerous and can kill.
- Do not use damaged, under sized, or badly joined cables.
- Do not drape cables over your body.
- We recommend (RCD) safety switch is used with this equipment to detect any leakage of current to earth.



Fumes and gases are dangerous. Smoke and gas generated whilst welding or cutting can be harmful to people's health. Welding produces fumes and gases. Breathing these fumes and gases can be hazardous to your health.

Do not breathe the smoke and gas generated whilst welding or cutting, keep your head out of the fumes

- Keep the working area well ventilated, use fume extraction or ventilation to remove welding/cutting fumes and gases.
- In confined or heavy fume environments always wear an approved air-supplied respirator.
- Welding/cutting fumes and gases can displace air and lower the oxygen level causing injury or death. Be sure the breathing air is safe.
- Do not weld/cut in locations near de-greasing, cleaning, or spraying operations. The heat and rays of the arc can react with vapours to form highly toxic and irritating gases.
- Materials such as galvanized, lead, or cadmium plated steel, containing elements that can give off toxic fumes when welded/cut. Do not weld/cut these materials unless the area is very well ventilated, and or wearing an air supplied respirator.



Arc rays: harmful to people's eyes and skin. Arc rays from the welding/cutting process produce intense visible and invisible ultraviolet and infrared rays that can burn eyes and skin.

Always wear a welding helmet with correct shade of filter lens and suitable protective clothing including welding gloves whilst the welding/cutting operation is performed.

- Measures should be taken to protect people in or near the surrounding working area. Use protective screens or barriers to protect others from flash, glare and sparks; warn others not to watch the arc.



Fire hazard. Welding/cutting on closed containers, such as tanks, drums, or pipes, can cause them to explode. Flying sparks from the welding/cutting arc, hot work piece, and hot equipment can cause fires and burns. Accidental contact of electrode to metal objects can cause sparks, explosion, overheating, or fire. Check and be sure the area is safe before doing any welding/cutting.

- The welding/cutting sparks & spatter may cause fire, therefore remove any flammable materials well away from the working area. Cover flammable materials and containers with approved covers if unable to be moved from the welding/cutting area.
- Do not weld/cut on closed containers such as tanks, drums, or pipes, unless they are properly prepared according to the required Safety Standards to insure that flammable or toxic vapours and substances are totally removed, these can cause an explosion even though the vessel has been “cleaned”. Vent hollow castings or containers before heating, cutting or welding. They may explode.
- Do not weld/cut where the atmosphere may contain flammable dust, gas, or liquid vapours (such as petrol)
- Have a fire extinguisher nearby and know how to use it. Be alert that welding/cutting sparks and hot materials from welding/cutting can easily go through small cracks and openings to adjacent areas. Be aware that welding/cutting on a ceiling, floor, bulkhead, or partition can cause fire on the hidden side.



Gas Cylinders. Shielding gas cylinders contain gas under high pressure. If damaged, a cylinder can explode. Because gas cylinders are normally part of the welding/cutting process, be sure to treat them carefully. CYLINDERS can explode if damaged.

- Protect gas cylinders from excessive heat, mechanical shocks, physical damage, slag, open flames, sparks, and arcs.
- Insure cylinders are held secure and upright to prevent tipping or falling over.
- Never allow the welding/cutting electrode or earth clamp to touch the gas cylinder, do not drape welding cables over the cylinder.
- Never weld/cut on a pressurised gas cylinder, it will explode and kill you.
- Open the cylinder valve slowly and turn your face away from the cylinder outlet valve and gas regulator.



Gas build up. The build up of gas can causes a toxic environment, deplete the oxygen content in the air resulting in death or injury. Many gases use in welding/cutting are invisible and odourless.

- Shut off shielding gas supply when not in use.
- Always ventilate confined spaces or use approved air-supplied respirator.



Electronic magnetic fields. MAGNETIC FIELDS can affect Implanted Medical Devices.

- Wearers of Pacemakers and other Implanted Medical Devices should keep away.
- Implanted Medical Device wearers should consult their doctor and the device manufacturer before going near any electric welding, cutting or heating operation.



Noise can damage hearing. Noise from some processes or equipment can damage hearing.

- Wear approved ear protection if noise level is high.



Hot parts. Items being welded/cut generate and hold high heat and can cause severe burns.

Do not touch hot parts with bare hands. Allow a cooling period before working on the welding/cutting gun. Use insulated welding gloves and clothing to handle hot parts and prevent burns.

CAUTION

1. Working Environment.

- i. The environment in which this welding/cutting equipment is installed must be free of grinding dust, corrosive chemicals, flammable gas or materials etc., and at no more than a maximum of 80% humidity.
- ii. When using the machine outdoors, protect the machine from direct sunlight, rainwater and snow, etc.; the temperature of the working environment should be maintained within -10°C to +40°C.
- iii. Keep this equipment 30cm distant from the wall.
- iv. Ensure the working environment is well ventilated.

2. Safety Tips.

- i. **Ventilation:** This equipment is small-sized, compact in structure, and of excellent performance in amperage output. The fan is used to dissipate heat generated by this equipment during the welding/cutting operation. Important: Maintain good ventilation of the louvres of this equipment. The minimum distance between this equipment and any other objects in or near the working area should be 30 cm. Good ventilation is of critical importance for the normal performance and service life of this equipment.
- ii. **Thermal Overload Protection:** Should the machine be used to an excessive level, or in a high-temperature environment, poorly ventilated area or if the fan malfunctions the Thermal Overload Switch will be activated, and the machine will cease to operate. Under this circumstance, leave the machine switched on to keep the built-in fan working to bring down the temperature inside the equipment. The machine will be ready for use again when the internal temperature reaches a safe level.
- iii. **Over-Voltage Supply:** Regarding the power supply voltage range of the machine, please refer to the "Main parameter" table. This equipment is of automatic voltage compensation, which enables the maintaining of the voltage range within the given range. In case that the voltage of input power supply amperage exceeds the stipulated value, it is possible to cause damage to the components of this equipment. Please ensure your primary power supply is correct.
- iv. Do not come into contact with the output terminals while the machine is in operation. An electric shock may occur.

MAINTENANCE

Exposure to extremely dusty, damp, or corrosive air is damaging to the welding/cutting machine. To prevent any possible failure or fault of this welding/cutting equipment, clean the dust at regular intervals with clean and dry compressed air of required pressure.

Please note that: lack of maintenance can result in the cancellation of the guarantee; the guarantee of this welding/cutting equipment will be void if the machine has been modified, attempt to take apart the machine or open the factory-made sealing of the machine without the consent of an authorized representative of the manufacturer.

TROUBLESHOOTING

Caution: Only qualified technicians are authorized to undertake the repair of this welding/cutting equipment. For your safety and to avoid Electrical Shock, please observe all safety notes and precautions detailed in this manual.

ATTENTION! - CHECK FOR GAS LEAKAGE

At initial set up and at regular intervals we recommend to check for gas leakage

Recommended procedure is as follows:

- 1.** Connect the regulator and gas hose assembly and tighten all connectors and clamps.
- 2.** Slowly open the cylinder valve.
- 3.** Set the flow rate on the regulator to approximately 8-10 L/min.
- 4.** Close the cylinder valve and pay attention to the needle indicator of the contents pressure gauge on the regulator, if the needle drops away towards zero there is a gas leak. Sometimes a gas leak can be slow and to identify it will require leaving the gas pressure in the regulator and line for an extended time period. In this situation it is recommended to open the cylinder valve, set the flow rate to 8-10 L/min, close the cylinder valve and check after a minimum of 15 minutes.
- 5.** If there is a gas loss then check all connectors and clamps for leakage by brushing or spraying with soapy water, bubbles will appear at the leakage point.
- 6.** Tighten clamps or fittings to eliminate gas leakage.

IMPORTANT! - We strongly recommend that you check for gas leakage prior to operation of your machine. We recommend that you close the cylinder valve when the machine is not in use.

Esseti NZ LTD, authorised representatives or agents of Esseti Nz LTD will not be liable or responsible for the loss of any gas.

XCEL-ARC™ TIG200RZ ACDC FEATURES



TIG/MMA - 200 Amp AC/DC Inverter Welder

Welds: Aluminium, Magnesium, Zinc Alloys, Steels, Stainless, Cast Iron, Bronze, Copper

TIG/MMA 200 Amp 230V AC/DC Inverter Welder
HF Start, Pulse, 2/4T, Down Slope, Post Gas
Industrial Rated, AC Balance, Remote Ready



Features

- Proven IGBT Inverter Technology
- AC/DC TIG
 - HF Arc Ignition
 - AC Balance control
 - Pulse Control Function
 - Adjustable Base current (Background Amps) 10~90%
 - Adjustable Down Slope 0~10 seconds
 - Adjustable Post Gas 0~10 seconds
 - 2/4T Trigger control
 - Remote Amperage Control - Optional
- MMA (stick electrode)
 - Adjustable Arc Force (adjusts arc energy to suit electrode application)
 - Excellent arc stability with all electrodes
- Water Cooler Ready
- Tolerant to variable power supply

XA-TIG200RZ ACDC Standard Package



Optional machine accessories available - refer www.xcelarc.nz

Technical Data

Power Supply	230V 1-Phase ±15%
Rated Input Power	6.9 kVA
I _{eff} as per AS/NZ60974-1	15 Amps
Rated Output	10~160A/26.8V MMA 10~200A/17.4V TIG
No Load Voltage	65V
Duty Cycle @ 40°C as per AS/NZ60974	30% @ 160 Amps MMA 25% @ 200 Amps TIG
Duty Cycle @ 25°C (approximate)	30% @ 160 Amps MMA 25% @ 200 Amps TIG
Efficiency	80%
Power Factor	0.7
Protection Class	IP21S
Insulation Class	B
Dimensions (LxWxH)	566 x 224 x 405mm
Weight	15 kg
Certification Approval	AS/NZ 60974-1

Overview

The Xcel-Arc TIG200RZ is a high quality inverter AC/DC TIG welding machine with added MMA (stick electrode) function. Produced using tried and tested IGBT inverter technology, this machine is highly reliable, robust and stacked with all the features that you would expect from an industrial welding machine. The TIG function incorporates Square Wave AC with adjustable AC Balance, making this an ideal choice for anyone wanting to TIG weld aluminium alloys with professional results. The HF Arc Ignition provides easy starting leaving no tungsten inclusion or contamination of the tungsten electrode. The adjustable Down Slope and Post-Gas combined with the 2/4T trigger function gives you flexibility to control the start and finish of the weld process at a professional level. The fully adjustable Pulse function including Pulse Frequency, and Base Current (Background Amps) gives you the added ability to better control heat input into the work, control penetration & minimize distortion. The Remote Control Interface provides for connection of remote amperage control via either optional Torch Remote or Foot Pedal. The MMA welding function delivers a smooth and stable arc allowing high quality welds including cast Iron, stainless and low hydrogen. The inclusion of adjustable Arc Force allows you to set the ideal arc condition no matter what type of electrode you choose. The TIG200RZ is an exceptional machine that has been widely popular across a broad spectrum of welding applications from light industrial situations right through to the serious hobby user wanting a professional level machine. Designed and built to our specification and manufactured in compliance to AS/NZ60974-1.

Product Code: XA-TIG200RZ ACDC-K

Standard Package includes: XA-TIG200RZ ACDC Machine, XA26FX Flexi-Neck Tig Torch x 4m, Earth Lead & Arc Lead 25mm x 4m, Argon Regulator



FRONT PANEL LAYOUT

1. Digital Control Panel (See page 10 for an enhanced detailed explanation of the controls)
2. “+” Output Terminal
3. “-” Output Terminal
4. 9 pin Remote Connection
5. Gas outlet



REAR PANEL LAYOUT





6. Water Cooler Supply Outlet
7. Water Cooler Fuse
8. Primary Power Input
9. ON/OFF Switch
10. Input Gas Connector

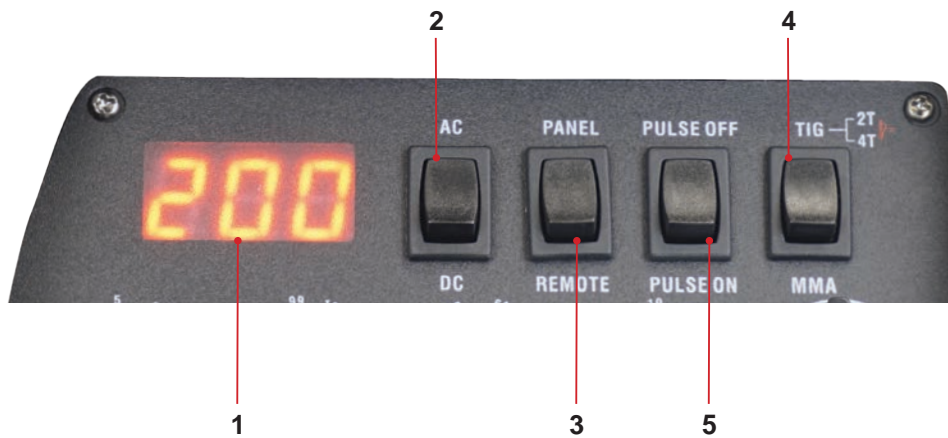

SELECTOR SWITCH FUNCTIONS



Selector Switch Function Descriptions





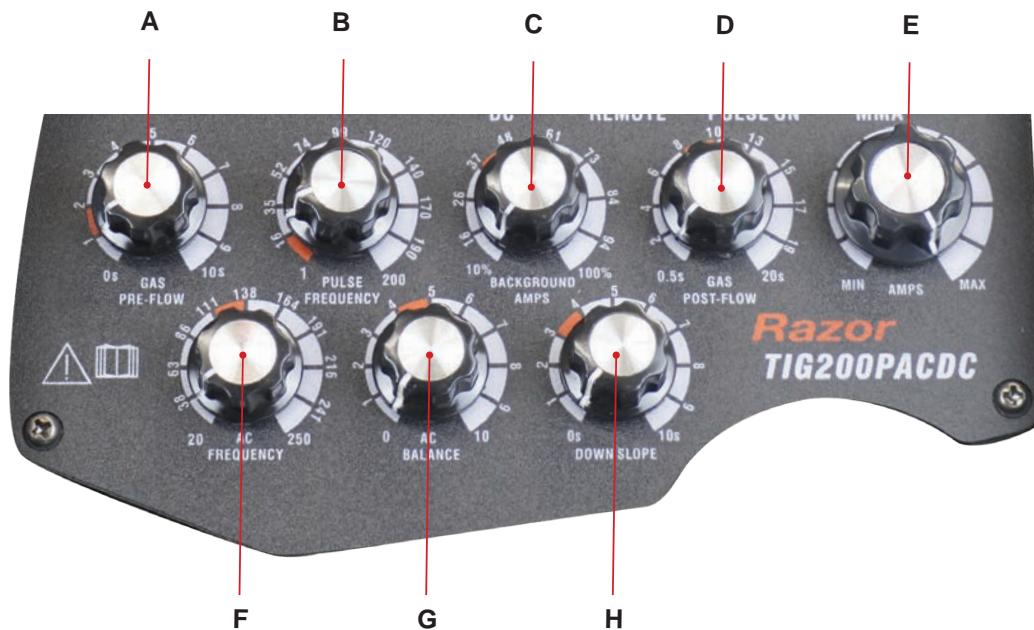

- 1**  **Digital Display Meter:** Displays actual current before and during welding as well as other parameter settings. Also used to display any error message codes.
- 2**  **AC/DC:** Provides selection of AC or DC Current.
 Selecting the **AC** position provides for AC welding current output.
 Selecting the **DC** position provides for DC welding current output.
- 3**  **Remote:** Provides selection of the remote output current (amps) control function. Selecting the **REMOTE** position allows use of the remote current (amperage) controls.
 Selecting the **PANEL** position allows current (amperage) control from the front panel Peak current control.
- 4**  **TIG/MMA:** Provides selection of TIG or MMA (Stick) welding modes.

 - Selecting the **TIG** position provides for TIG welding function.
 - 2T/4T:** Provides control over the arc ignition, weld cycle and finishing of the weld using the torch trigger switch.
 - 2T** Selection provides 2 times function of the torch switch
 - (1) Pressing the torch switch gives arc ignition and initializes the welding current
 - (2) Releasing the torch switch introduces down slope time to minimum current level and then terminates the welding current and introduces the post flow gas
 - 4T** Selection provides 4 times function of the torch switch
 - (1) Pressing the torch switch gives arc ignition and initializes the welding current
 - (2) Releasing the torch switch continues the welding operation.
 - (3) Pressing the torch switch introduces down slope and current falls to minimum current
 - (4) Releasing the torch switch terminates the welding operation and introduces the post flow gas.
 - Selecting the **MMA** position provides for Manual Metal Arc (Stick)welding function.
- 5**  **Pulse Selector:** Provides selection of Pulse welding mode.
 Selecting the **ON** position place the machine in Pulse welding mode. 
 Selecting the **OFF** position place the machine in standard (non Pulse) welding mode. 



CONTROL DIAL FUNCTIONS



- A**  **Gas Pre Flow:** Provides a pre-flow of gas to purge tig torch gas line prior to the initialisation of the arc. Helps arc ignition and prevents porosity in the weld start. Adjustment is 0-1sec.
- B**  **Pulse Frequency Control:** This control allows the setting of the pulse frequency (pulses per second) when in the pulse welding mode. Adjustment range is 1-200Hz.
- C**  **Background Amps:** For setting the base current in pulse welding. It is a percentage of the peak welding current, for example Peak Current set at 100 amps - Base Current set at 20% (20 amps) the output current will go from 100 amps down to 20 amps during each pulse cycle. The Pulse Width is pre-set at 50 %, so 50% of the pulse time is at the Peak Current and 50% of the time is at the Base Current. Background Amps Adjustment range is 10 - 100%.
- D**  **Gas Post Flow:** Provides adjustment and control of an after flow of gas when the welding arc is extinguished. Post flow gas prevents contamination of the weld pool during its cool down period from molten state to solid at the weld finish also keeping the tungsten electrode protected from oxidising atmosphere during the cool down cycle. The Gas Post flow time will depend of the tusten size and welding current that is being used, when the Gas Post Flow is set correctly the tungsten electrode will have a clean shiny finish. Adjustment 0-20sec.
- E**  **Amps:** Provides adjustment and control of the main welding current. (peak current when in pulse mode)
Adjustment range 10-200 Amps.(TIG)
10-160 Amps.(MMA)

CONTROL DIAL FUNCTIONS



- F**  **AC Frequency:** For adjusting the AC square wave frequency in AC TIG mode. Controls the amount of times per second (Hz) AC Wave form switches from + positive to - negative cycle. Adjustment range is 20-250 Hz
- H**  **AC Balance:** Controls percentage of time spent in the + positive polarity during AC welding. There is an oxide film on the surface of aluminium that needs to be removed to allow welding of the base material. The oxide film is removed during the + positive side of the AC wave form. The knob controls the % of time spent in the + positive (cleaning) cycle of the AC wave. The higher the setting the more aggressive is the cleaning action, therefore more time during the + positive cycle drives more energy into the tungsten so care needs to be taken not to overheat and melt the tungsten by setting it too high. Less % of + positive cycle produces a more penetrating arc. Adjustment range is 0^(+15%) - 10^(+85%)
- D**  **Down Slope:** For setting the down slope time at the end of the welding cycle. The welding current will reduce down during the time set at the dial. This helps eliminate craters or pin holes forming at the end of the weld. Adjustment is 0-10sec.

INSTALLATION SET UP FOR MMA (STICK) WELDING



Installation set up for MMA (Stick) Welding with XA-TIG200RZ ACDC

(1) Turn the power source on and select the **MMA** function with the Tig/MMA selector switch.

(2) Connection of Output Cables

Two sockets are available on this welding machine. For MMA welding the electrode holder is shown be connected to the positive socket, while the earth lead (work piece) is connected to the negative socket, this is known as DC+ polarity. However various electrodes require a different polarity for optimum results and careful attention should be paid to the polarity, refer to the electrode manufacturers information for the correct polarity.

DC+ Electrode connected to (+) output socket.

DC- Electrode connected to (-) output socket.



(1) Turn on the machine using the ON/OFF switch

Set Tig/MMA Selector switch to MMA

(2) Connect the Electrode lead to (+) terminal

(3) Connect Earth Lead the (-) terminal

INSTALLATION SET UP FOR MMA (STICK) WELDING



continued set up and operation for MMA (Stick) Welding

- (3) Set the welding current relevant to the electrode type and size being used as recommended by the electrode manufacturer
- (4) Place the electrode into the electrode holder and clamp tight
- (5) Strike the electrode against the workpiece to create and arc and hold the electrode steady to maintain the arc
- (6) Hold the electrode slightly above the work piece to maintain the arc while travelling at an even speed to create and even weld deposition
- (7) To finish the weld, break the arc by quickly snapping the electrode away from the work piece.
- (8) Wait for the weld to cool and carefully chip away the slag to reveal the weld metal underneath



3) Set the welding current using the amperage control dial



4) Place the electrode into the electrode holder and clamp tight.



5) Strike the electrode against the work piece to create and arc and hold the electrode steady to maintain the arc



6) Hold the electrode slightly above the work piece to maintain the arc while travelling at an even speed to create and even weld deposition.



7) To finish the weld, break the arc by quickly snapping the electrode away from the work piece.

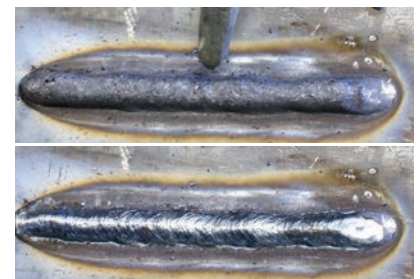

8) Wait for the weld to cool and carefully chip away the slag to reveal the weld metal below.

MMA(STICK) WELDING GUIDE



MMA (Manual Metal Arc) Welding

One of the most common types of arc welding is manual metal arc welding (MMA) or stick welding. An electric current is used to strike an arc between the base material and a consumable electrode rod or 'stick'. The electrode rod is made of a material that is compatible with the base material being welded and is covered with a flux that gives off gaseous vapours that serve as a shielding gas and providing a layer of slag, both of which protect the weld area from atmospheric contamination. The electrode core itself acts as filler material the residue from the flux that forms a slag covering over the weld metal must be chipped away after welding.

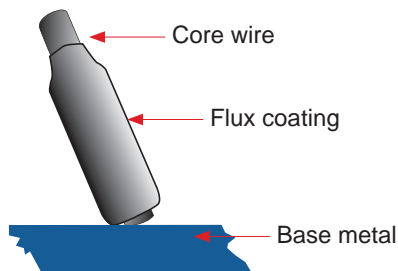
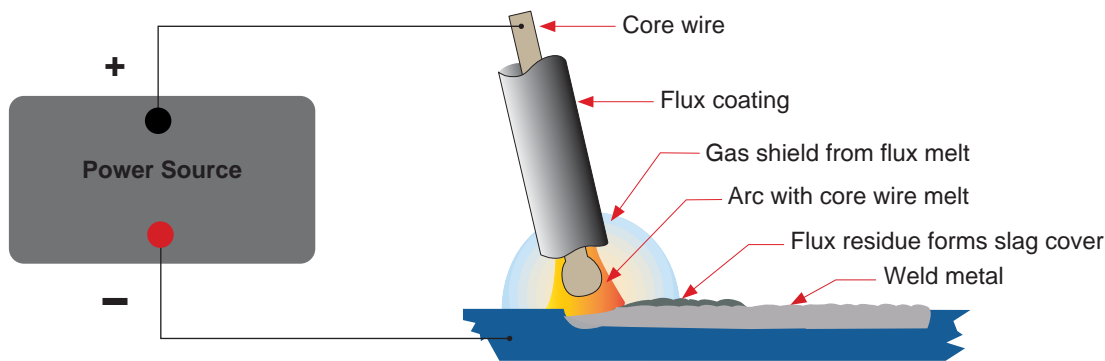

- The arc is initiated by momentarily touching the electrode to the base metal.
- The heat of the arc melts the surface of the base metal to form a molten pool at the end of the electrode.
- The melted electrode metal is transferred across the arc into the molten pool and becomes the deposited weld metal.
- The deposit is covered and protected by a slag which comes from the electrode coating.
- The arc and the immediate area are enveloped by an atmosphere of protective gas

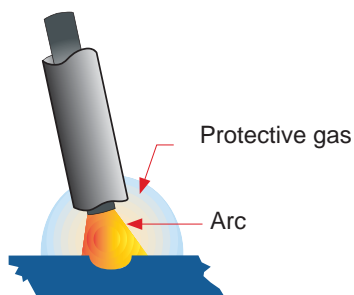

Manual metal arc (stick) electrodes have a solid metal wire core and a flux coating. These electrodes are identified by the wire diameter and by a series of letters and numbers. The letters and numbers identify the metal alloy and the intended use of the electrode.

The **Metal Wire Core** works as conductor of the current that maintains the arc. The core wire melts and is deposited into the welding pool.

The covering on a shielded metal arc welding electrode is called **Flux**. The flux on the electrode performs many different functions. These include:

- producing a protective gas around the weld area
- providing fluxing elements and deoxidizers
- creating a protective slag coating over the weld as it cools
- establishing arc characteristics
- adding alloying elements.

Covered electrodes serve many purposes in addition to adding filler metal to the molten pool. These additional functions are provided mainly by the covering on the electrode.

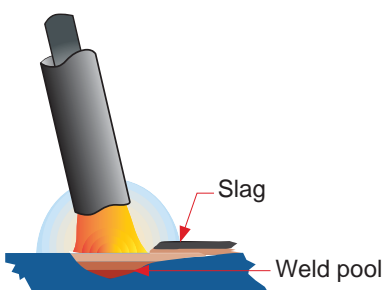

MMA (Stick) Welding Fundamentals

Electrode Selection

As a general rule, the selection of an electrode is straight forward, in that it is only a matter of selecting an electrode of similar composition to the parent metal. However, for some metals there is a choice of several electrodes, each of which has particular properties to suit specific classes of work. It is recommended to consult your welding supplier for the correct selection of electrode.

Electrode Size

Average Thickness of Material	Maximum Recommended Electrode Diameter
1.0 - 2.0mm	2.5mm
2.0 - 5.0mm	3.2mm
5.0 - 8.0mm	4.0mm
8.0 - > mm	5.0mm

The size of the electrode generally depends on the thickness of the section being welded, and the thicker the section the larger the electrode required. The table gives the maximum size of electrodes that maybe used for various thicknesses of section based on using a general purpose type 6013 electrode.

Welding Current (Amperage)

Electrode Size \varnothing mm	Current Range (Amps)
2.5mm	60 - 95
3.2mm	100 - 130
4.0mm	130 - 165
5.0mm	165 - 260

Correct current selection for a particular job is an important factor in arc welding. With the current set too low, difficulty is experienced in striking and maintaining a stable arc. The electrode tends to stick to the work, penetration is poor and beads with a distinct rounded profile will be deposited. Too high current is accompanied by overheating of the electrode resulting in undercut and burning through of the base metal and producing

excessive spatter. Normal current for a particular job may be considered as the maximum, which can be used without burning through the work, over-heating the electrode or producing a rough spattered surface. The table shows current ranges generally recommended for a general purpose type 6013 electrode.

Arc Length

To strike the arc, the electrode should be gently scraped on the work until the arc is established. There is a simple rule for the proper arc length; it should be the shortest arc that gives a good surface to the weld. An arc too long reduces penetration, produces spatter and gives a rough surface finish to the weld. An excessively short arc will cause sticking of the electrode and result in poor quality welds. General rule of thumb for down hand welding is to have an arc length no greater than the diameter of the core wire.

Electrode Angle

The angle that the electrode makes with the work is important to ensure a smooth, even transfer of metal. When welding in down hand, fillet, horizontal or overhead the angle of the electrode is generally between 5 and 15 degrees towards the direction of travel. When vertical up welding the angle of the electrode should be between 80 and 90 degrees to the work piece.

Travel Speed

The electrode should be moved along in the direction of the joint being welded at a speed that will give the size of run required. At the same time, the electrode is fed downwards to keep the correct arc length at all times. Excessive travel speeds lead to poor fusion, lack of penetration etc, while too slow a rate of travel will frequently lead to arc instability, slag inclusions and poor mechanical properties.

Material and Joint Preparation

The material to be welded should be clean and free of any moisture, paint, oil, grease, mill scale, rust or any other material that will hinder the arc and contaminate the weld material. Joint preparation will depend on the method used include sawing, punching, shearing, machining, flame cutting and others. In all cases edges should be clean and free of any contaminants. The type of joint will be determined by the chosen application.

INSTALLATION SET UP FOR DC TIG WELDING



- (1) Turn on the machine using the **ON/OFF** switch
- (2) Select the **TIG** function with the **TIG/MMA** selector switch.
- (3) Select **DC** using the **AC/DC** selector switch.
- (4) Connect the **Tig Torch** connector to the **negative terminal** and tighten it.
- (5) Connect the **Earth Cable** connector into the **positive terminal** and tighten it.
- (6) Connect the torch switch remote lead into the torch remote socket
- (7) Insert the torch gas connector into the quick lock gas receptacle.
- (8) Connect gas line to Gas Regulator and connect the gas regulator to the Gas Cylinder.



INSTALLATION SET UP FOR DC TIG WELDING



DC HF TIG Operation with XA-TIG200RZ ACDC

HF (high frequency) ignition allows the arc to be started in Tig welding without touching the tungsten to the work piece. By pressing the torch switch the machine will activate the gas flow and the HF ignition resulting in the arc igniting across the gap between the tungsten electrode and the work piece. The distance between the electrode and the work piece can be up to 5mm. This arc ignition method prevents tungsten inclusion in the work piece, promotes longer tungsten life and offers better operator control over the starting and stopping the arc.

- (1) Assemble the front end torch parts use the correct size and type of tungsten electrode for the job, the tungsten electrode requires a sharpened point for DC welding.
- (2) Choose **2T** or **4T** trigger function preferred as per the descriptions below
2T Selection provides 2 times function of the torch switch.
 - (1) Pressing the torch switch gives arc ignition and initializes the welding current and the welding current is maintained by the torch remaining on.
 - (2) Releasing the torch switch stops the welding by introducing down slope and the current falls to minimum level and then terminates the welding current and introduces the post flow gas.**4T** Selection provides 4 times function of the torch switch
 - (1) Pressing the torch switch gives arc ignition and initializes the welding current
 - (2) Releasing the torch switch continues the welding operation.
 - (3) Pressing the torch switch and holding introduces down slope and current falls to minimum current.
 - (4) Releasing the torch switch terminates the welding operation and introduces the post flow gas.
- (3) Choose the preferred welding current (amperage) to suit the tungsten size material type and thickness to be welded.
- (4) Lay the outside edge of the Gas Cup on the work piece with the Tungsten Electrode 1- 3mm from the work piece this method will provide a clean positive arc ignition.
- (5) Press the torch switch and the arc will ignite across the gap between the tungsten and work piece. Hold even distance of about 2mm gap between the tungsten and work piece to maintain the arc.
- (6) Release the torch switch to bring in the end of the welding sequence dependant of 2T or 4T trigger function choice.



(1) Assemble the front end torch parts use the correct size and type of tungsten electrode for the job, the tungsten electrode requires a sharpened point for DC welding



(2) Switch to the TIG function and the machine indicates what mode it is currently on (2T or 4T). To change the mode, switch off to MMA mode and back to TIG. Select **2T** or **4T** trigger function as required.



(3) Set the Peak Current (amps) to suit the tungsten size material type and thickness to be welded.



(4) Lay the outside edge of the Gas Cup on the work piece with the Tungsten Electrode 1- 3mm from the work piece



(5) Press the torch switch and the arc will ignite across the gap between the tungsten and work piece. Hold even distance of about 2mm gap between the tungsten and work piece to maintain the arc.

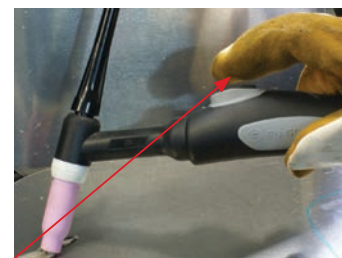

(6) Release the torch switch to bring in the end of the welding sequence dependant of 2T or 4T trigger function choice

DC TIG Welding

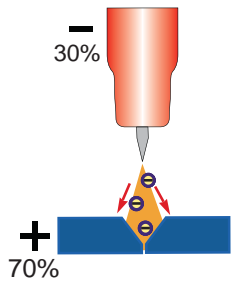

The DC power source uses what is known as DC (direct current) in which the main electrical component known as electrons flow in only one direction from the negative pole (terminal) to the positive pole (terminal). In the DC electrical circuit there is an electrical principle at work which should always be taken into account when using any DC circuit. With a DC circuit 70% of the energy (heat) is always on the positive side. This needs to be understood because it determines what terminal the TIG torch will be connected to (this rule applies to all the other forms of DC welding as well).

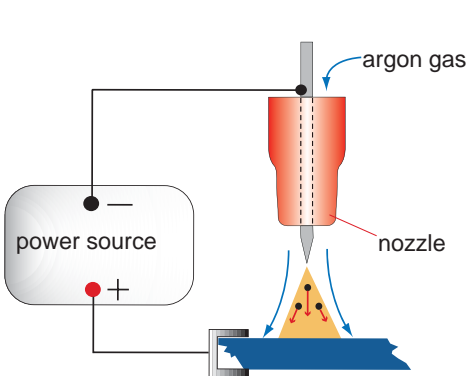

DC TIG welding is a process in which an arc is struck between a TUNGSTEN electrode and the metal work piece. The weld area is shielded by an inert gas flow to prevent contamination of the tungsten, molten pool and weld area.

When the TIG arc is struck the inert gas is ionized and superheated changing its molecular structure which converts it into a plasma stream. This plasma stream flowing between the tungsten and the work piece is the TIG arc and can be as hot as 19,000°C. It is a very pure and concentrated arc which provides the controlled melting of most metals into a weld pool. TIG welding offers the user the greatest amount of flexibility to weld the widest range of material and thickness and types. DC TIG welding is also the cleanest weld with no sparks or spatter.

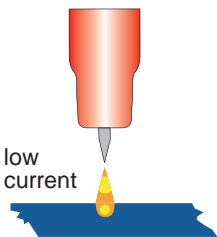

The intensity of the arc is proportional to the current that flows from the tungsten. The welder regulates the welding current to adjust the power of the arc. Typically thin material requires a less powerful arc with less heat to melt the material so less current (amps) is required, thicker material requires a more powerful arc with more heat so more current (amps) are necessary to melt the material.

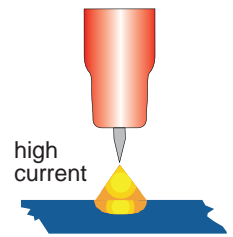

HF ARC IGNITION for TIG (tungsten inert gas) Welding

HF (high frequency) ignition allows the arc to be started in Tig welding without touching the tungsten to the work piece. By pressing the torch switch the machine will activate the gas flow and introduce the HF (high frequency) (high voltage) spark, this “ionizes” the air gap making it conductive allowing an arc to be created without touching the tungsten to the work piece. The gas molecules are superheated by the arc creating a stream of super heated gas that changes the molecular structure into producing a plasma stream. This plasma stream provides heat and energy that allows us to melt and fuse metals in an inert gas shielded environment know as TIG (tungsten inert gas) welding.

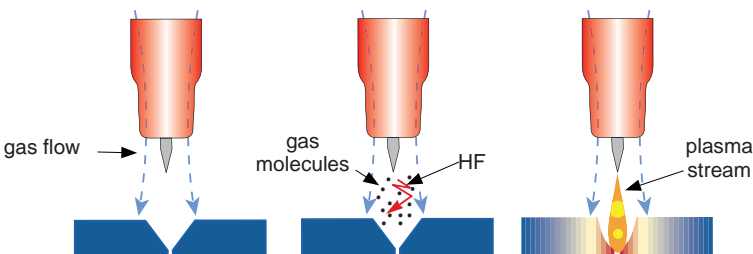

DC Pulse TIG Welding

Pulse TIG welding is when the current output (amperage) changes between high and low current. Electronics within the welding machine create the pulse cycle. Welding is done during the high-amperage interval (this high amperage is referred to as peak current). During the low amperage period, the arc is maintained but the current output of the arc is reduced (this low amperage is referred to as base current). During pulse welding the weld pool cools during the low amperage period. This allows a lower overall heat input into the base metal. It allows for controlled heating and cooling periods during welding providing better control of heat input, weld penetration, operator control and weld appearance.

There are 4 variables within the pulse cycle:

Peak Current - Base Current - Pulse Frequency - Pulse Width

Setting and manipulation of these variables will determine the nature of the weld current output and is at the discretion of the operator.

Peak Current is the main welding current (amps) set to melt the material being welded and works much the same as setting maximum amperage values for regular DC TIG: as a guide use 30-40 amps for every 1mm of material thickness.

Base Current is the set level of background current (amps) which cools the weld puddle and affects overall heat input. Background Amps is a percentage of peak amperage. As a rule, use enough background current to reduce the weld pool to about half its normal size while still keeping the weld pool fluid. As a guide start by setting the background amperage at 20 to 30 percent of peak amperage.

Pulse Frequency is the control of the amount of times per second (Hz) that the welding current switches from Peak Current to Base Current. DC Pulse TIG frequency generally ranges from 20 to 300 Hz depending on the job application. Control of the pulse frequency also determines the appearance of the weld.

Pulse Width is the percentage of time the machine spends at the peak current during 1 x pulse cycle.

The Pulse Width for this machine is pre-set at 50 %, therefore the machine will spend 50% of the pulse at peak current and 50% at the base current.

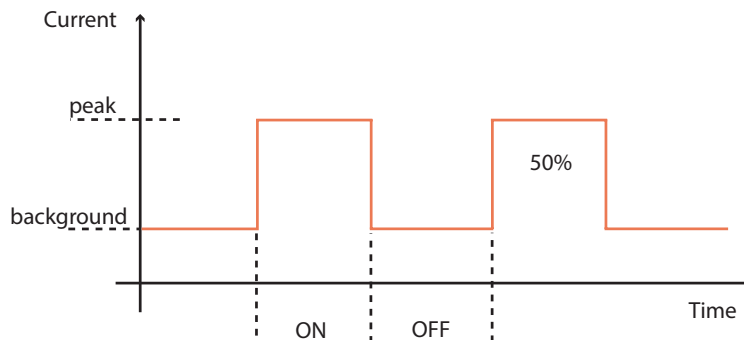

DC Pulse Tig welding allows faster welding speeds with better control of the heat input to the job, reducing the heat input minimising distortion and warping of the work and is of particular advantage in the welding of thin stainless steel and carbon steel applications. The high pulse frequency capability of the advanced inverter agitates the weld puddle and allows you to move quickly without transferring too much heat to the surrounding metal. Pulsing also constricts and focuses the arc thus increasing arc stability, penetration and travel speeds.

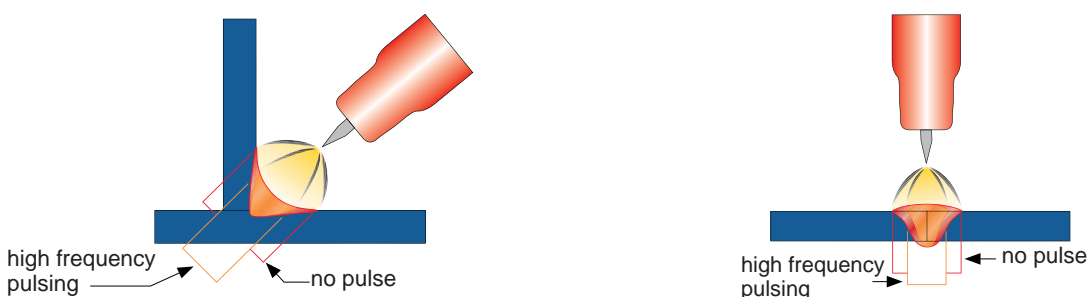

EXAMPLE 1 OF PULSE DC TIG WELDING - SETUP PARAMETERS:

Material = Stainless Steel x 2.0mm / Tungsten Electrode = 1.6mm 2% Thoriated / Gas = Argon

The following steps are a guide as a starting point for you to set the machine up in Pulse mode to give an example of welding in Pulse mode function. You can experiment by changing any of the variables to see what effect it has over the welding and what the end result can be, but it is suggested to change only one variable at a time and then check the welding to see what the result is, in this way you acquire a better understanding of how each variable affects the welding current.

- (1) Prepare the machine for DC TIG welding as per the DC HF TIG operating guide on page
- (2) Set the **Peak Current** at 110 Amps
- (3) Set the **Base Current** around 30% (Base Current is % of the Peak Current eg 30% of 110 = 33 Amps)
- (4) Set the **Pulse Frequency** around 2Hz (pulses per second)

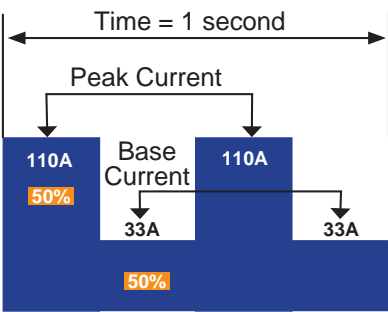

(2) Set the Peak Current at 110 Amps



(3) Set the Base Current at 30%



(4) Set the Pulse Frequency at 2 Hz



(6) Set the Pulse Selector switch to Pulse ON

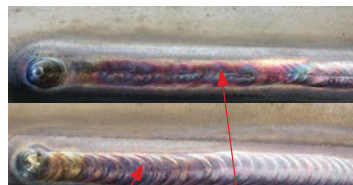

Example of Pulse vs Non Pulse weld finish

EXAMPLE 2 OF PULSE DC TIG WELDING - SETUP PARAMETERS:

Material = Mild Steel x 4.0mm / Tungsten Electrode = 2.4mm 2% Thoriated / Gas = Argon

- (1) Set the **Peak Current** at 150 Amps
- (2) Set the **Base Current** around 20% (Base Current is % of the Peak Current eg 40% of 180 = 72 Amps)
- (3) Set the **Pulse Frequency** around 1Hz (pulse per second)

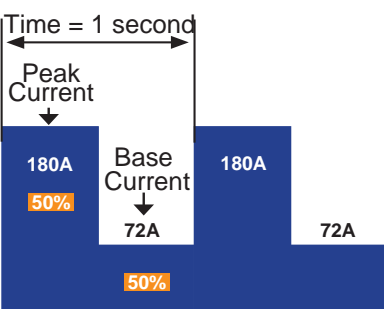

TIG Welding Fusion Technique

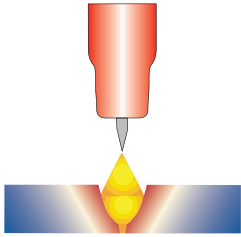

Manual TIG welding is often considered the most difficult of all the welding processes. Because the welder must maintain a short arc length, great care and skill are required to prevent contact between the electrode and the workpiece. Similar to Oxygen Acetylene torch welding, TIG welding normally requires two hands and in most instances requires the welder to manually feed a filler wire into the weld pool with one hand while manipulating the welding torch in the other. However, some welds combining thin materials can be accomplished without filler metal like edge, corner, and butt joints.

This is known as Fusion welding where the edges of the metal pieces are melted together using only the heat and arc force generated by the TIG arc. Once the arc is started the torch tungsten is held in place until a weld pool is created, a circular movement of the tungsten will assist in creating a weld pool of the desired size. Once the weld pool is established tilt the torch at about a 75° angle and move smoothly and evenly along the joint while fusing the materials together.

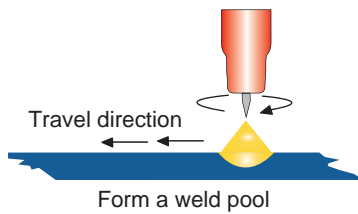

Form a weld pool

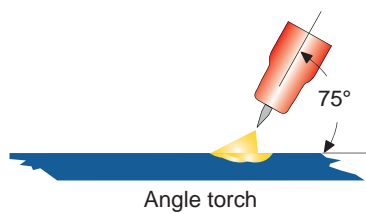

Angle torch

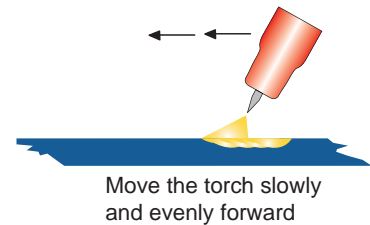

Move the torch slowly and evenly forward

TIG Welding with Filler Wire Technique

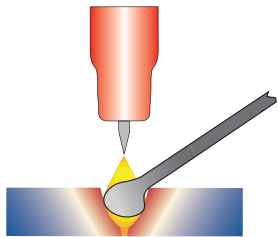

It is necessary in many situations with TIG welding to add a filler wire into the weld pool to build up weld reinforcement and create a strong weld. Once the arc is started the torch tungsten is held in place until a weld pool is created, a circular movement of the tungsten will assist in creating a weld pool of the desired size. Once the weld pool is established tilt the torch at about a 75° angle and move smoothly and evenly along the joint. The filler metal is introduced to the leading edge of the weld pool. The filler wire is usually held at about a 15° angle and fed into the leading edge of the molten pool, the arc will melt the filler wire into the weld pool as the torch is moved forward. Also a dabbing technique can be used to control the amount of filler wire added, the wire is fed into the molten pool and retracted in a repeating sequence as the torch is moved slowly and evenly forward. It is important during the welding to keep the molten end of the filler wire inside the gas shield as this protects the end of the wire from being oxidised and contaminating the weld pool.

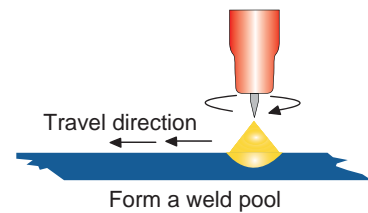

Form a weld pool

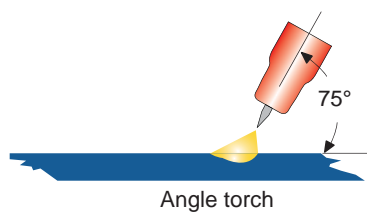

Angle torch

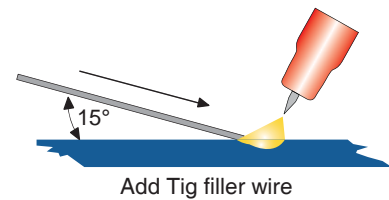

Add TIG filler wire

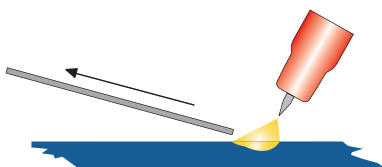

Retract the filler wire

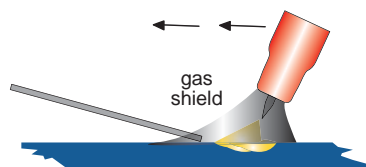

Move the torch forward to the front of the weld pool

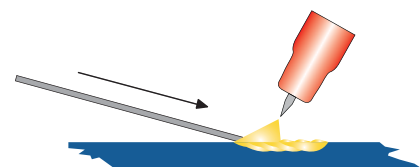

Repeat the process

Tungsten Electrodes

Tungsten is a rare metallic element used for manufacturing TIG welding electrodes. The TIG process relies on tungsten's hardness and high-temperature resistance to carry the welding current to the arc. Tungsten has the highest melting point of any metal, 3,410 degrees Celsius. Tungsten electrodes are nonconsumable and come in a variety of sizes, they are made from pure tungsten or an alloy of tungsten and other rare earth elements. Choosing the correct tungsten depends on the material being welded, amps required and whether you are using AC or DC welding current. Tungsten electrodes are colour-coded at the end for easy identification. Below are the most commonly used tungsten electrodes found in the New Zealand and Australian market.

Thoriated

Thoriated tungsten electrodes (AWS classification EWTh-2) contain a minimum of 97.30 percent tungsten and 1.70 to 2.20 percent thorium and are called 2 percent thoriated. They are the most commonly used electrodes today and are preferred for their longevity and ease of use. Thorium however is a low-level radioactive hazard and many users have switched to other alternatives. Regarding the radioactivity, thorium is an alpha emitter but when it is enclosed in a tungsten matrix the risks are negligible. Thoriated tungsten should not get in contact with open cuts or wounds. The more significant danger to welders can occur when thorium oxide gets into the lungs. This can happen from the exposure to vapours during welding or from ingestion of material/dust in the grinding of the tungsten. Follow the manufacturer's warnings, instructions, and the Material Safety Data Sheet (MSDS) for its use.

E3 (Color Code: Turquoise)

E3 tungsten electrodes (AWS classification EWG) contain a minimum of 98% percent tungsten and up to 1.5 percent Lanthanum and small percentages of Zirconium and Yttrium they are called E3 Tungsten. E3 Tungsten Electrodes provide conductivity similar to that of thoriated electrodes. Typically, this means that E3 Tungsten Electrodes are exchangeable with thoriated electrodes without requiring significant welding process changes. E3 deliver superior arc starting, electrode lifetime, and overall cost-effectiveness. When E3 Tungsten Electrodes are compared with 2% thoriated tungsten, E3 requires fewer re-grinds and provides a longer overall lifetime. Tests have shown that ignition delay with E3 Tungsten Electrodes actually improves over time, while 2% thoriated tungsten starts to deteriorate after only 25 starts. At equivalent energy output, E3 Tungsten Electrodes run cooler than 2% thoriated tungsten, thereby extending overall tip lifetime. E3 Tungsten Electrodes work well on AC or DC. They can be used DC electrode positive or negative with a pointed end, or balled for use with AC power sources.

Ceriated (Color Code: Grey)

Ceriated tungsten electrodes (AWS classification EWCe-2) contain a minimum of 97.30 percent tungsten and 1.80 to 2.20 percent cerium and are referred to as 2 percent ceriated. Ceriated tungstens perform best in DC welding at low current settings. They have excellent arc starts at low amperages and become popular in such applications as orbital tube welding, thin sheet metal work. They are best used to weld carbon steel, stainless steel, nickel alloys, and titanium, and in some cases it can replace 2 percent thoriated electrodes. Ceriated tungsten is best suited for lower amperages it should last longer than Thoriated tungsten higher amperage applications are best left to Thoriated or Lanthanated tungsten.

Lanthanated (Color Code: Gold)

Lanthanated tungsten electrodes (AWS classification EWLa-1.5) contain a minimum of 97.80 percent tungsten and 1.30 percent to 1.70 percent lanthanum, and are known as 1.5 percent lanthanated. These electrodes have excellent arc starting, a low burn off rate, good arc stability, and excellent re-ignition characteristics. Lanthanated tungstens also share the conductivity characteristics of 2 percent thoriated tungsten. Lanthanated tungsten electrodes are ideal if you want to optimise your welding capabilities. They work well on AC or DC electrode negative with a pointed end, or they can be balled for use with AC sine wave power sources. Lanthanated tungsten maintains a sharpened point well, which is an advantage for welding steel and stainless steel on DC or AC from square wave power sources.

Zirconiated (Color Code: White)

Zirconiated tungsten electrodes (AWS classification EWZr-1) contain a minimum of 99.10 percent tungsten and 0.15 to 0.40 percent zirconium. Most commonly used for AC welding Zirconiated tungsten produces a very stable arc and is resistant to tungsten spitting. It is ideal for AC welding because it retains a balled tip and has a high resistance to contamination. Its current-carrying capacity is equal to or greater than that of thoriated tungsten. Zirconiated tungsten is not recommended for DC welding.

Tungsten Electrodes Rating for Welding Currents

Tungsten Diameter mm	DC Current Amps Torch Negative 2% Thoriated	AC Current Amps Un-Balanced Wave 0.8% Zirconiated	AC Current Amps Balanced Wave 0.8% Zirconiated
1.0mm	15 - 80	15 - 80	20 - 60
1.6mm	70 - 150	70 - 150	60 - 120
2.4mm	150 - 250	140 - 235	100 - 180
3.2mm	250 - 400	225 - 325	160 - 250
4.0mm	400 - 500	300 - 400	200 - 320

Tungsten Preparation

Always use **DIAMOND** wheels when grinding and cutting. While tungsten is a very hard material, the surface of a diamond wheel is harder, and this makes for smooth grinding. Grinding without diamond wheels, such as aluminium oxide wheels, can lead to jagged edges, imperfections, or poor surface finishes not visible to the eye that will contribute to weld inconsistency and weld defects.

Always ensure to grind the tungsten in a longitudinal direction on the grinding wheel. Tungsten electrodes are manufactured with the molecular structure of the grain running lengthwise and thus grinding crosswise is “grinding against the grain.” If electrodes are ground crosswise, the electrons have to jump across the grinding marks and the arc can start before the tip and wander. Grinding longitudinally with the grain, the electrons flow steadily and easily to the end of the tungsten tip. The arc starts straight and remains narrow, concentrated, and stable.



Electrode Tip/Flat

The shape of the tungsten electrode tip is an important process variable in precision arc welding. A good selection of tip/flat size will balance the need for several advantages. The bigger the flat, the more likely arc wander will occur and the more difficult it will be to arc start. However, increasing the flat to the maximum level that still allows arc start and eliminates arc wander will improve the weld penetration and increase the electrode life. Some welders still grind electrodes to a sharp point, which makes arc starting easier. However, they risk decreased welding performance from melting at the tip and the possibility of the point falling off into the weld pool.



Electrode Included Angle/Taper - DC Welding

Tungsten electrodes for DC welding should be ground longitudinally and concentrically with diamond wheels to a specific included angle in conjunction with the tip/flat preparation. Different angles produce different arc shapes and offer different weld penetration capabilities. In general, blunter electrodes that have a larger included angle provide the following benefits:

- Last Longer
- Have better weld penetration
- Have a narrower arc shape
- Can handle more amperage without eroding.

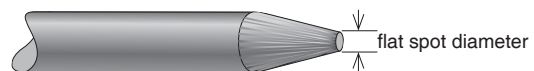

Sharper electrodes with smaller included angle provide:

- Offer less arc weld
- Have a wider arc
- Have a more consistent arc

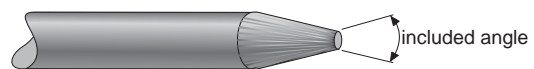

The included angle determines weld bead shape and size. Generally, as the included angle increases, penetration increases and bead width decreases.

Tungsten Diameter	Diameter at the Tip - mm	Constant Included Angle - Degrees	Current Range Amps	Current Range Pulsed Amps
1.0mm	.250	20	05 - 30	05 - 60
1.6mm	.500	25	08 - 50	05 - 100
1.6mm	.800	30	10 - 70	10 - 140
2.4mm	.800	35	12 - 90	12 - 180
2.4mm	1.100	45	15 - 150	15 - 250
3.2mm	1.100	60	20 - 200	20 - 300
3.2mm	1.500	90	25 - 250	25 - 350

Tungsten preparation AC Welding

To obtain full current capacity from a pure or zirconiated tungsten electrode when used with AC current output the electrode is not ground to a point. The welding during positive polarity melts the point of the tungsten that becomes rounded. The ball shape formed at the end of the tungsten is desirable because it reduces current rectification and allows the arc to flow more easily.

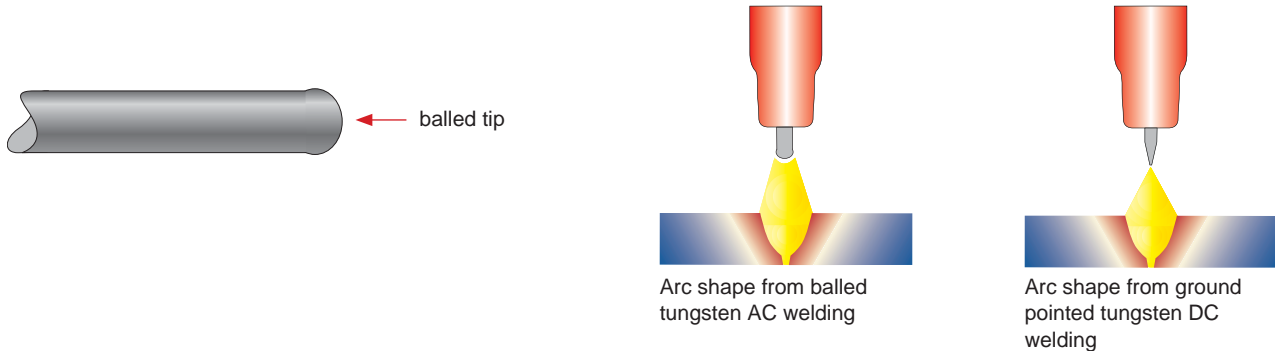

Safety with tungsten electrodes

Tungsten welding electrodes should never be manually ground on an abrasive belt or wheel (particularly silicone carbide). Always use diamond wheels when grinding and cutting tungstens. The risk of injury when hand (manually) grinding a very hard brittle material like tungsten is quite high. It is important to always follow standard safety guidelines when operating high speed grinding equipment.

- Wear approved safety glasses
- No loose clothing which may get caught in moving parts
- Wear protective hair covering to contain long hair
- Wear safety shoes with non-slip sole
- A vacuum system is recommended to remove tungsten, especially thorium dust
- Never operate power tools when tired, intoxicated or when taking medication that causes drowsiness

The most common injuries to the manual tungsten electrode grinder are eye and finger related. Holding and grinding the tungsten electrode by hand has resulted in burned fingers, laceration to fingers and splintered tungsten electrodes in hand or fingers. Eye injury generally occurs from manually grinding tungsten electrodes without a safety shield or safety glasses. Small slivers of tungsten electrode may become stuck in the operator's eye.

Remote Amperage Controls - Installation and Operation

Remote amperage controls allow for the welding current to be adjusted remotely from the welding machine during welding. Generally there are several types of remote amperage control available;

- (1) Hand amperage control located in the torch handle allowing the operator to adjust the welding current by rolling the potentiometer wheel to increase or decrease the amount of amperage desired.
- (2) Foot amperage control that is a foot pedal that allows the operator to adjust the welding current by depressing the pedal to increase the amperage desired and releasing the pedal to decrease.
- (3) Box amperage control that is a small box housing a potentiometer with a knob that the operator can adjust the welding current turning the knob to increase or decrease the amount of amperage desired.

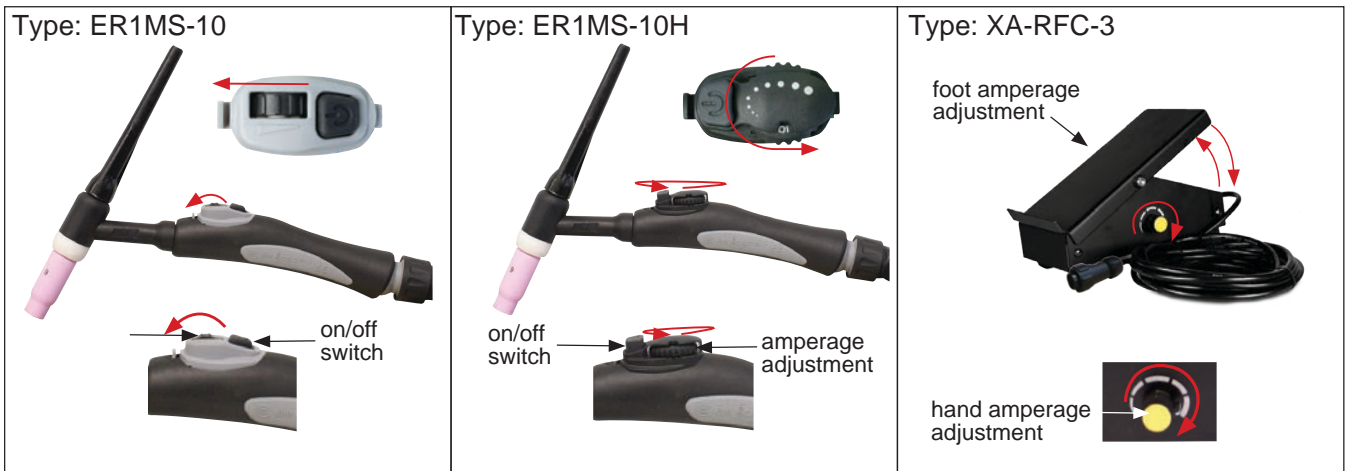

Connection and operation of the remote hand control



(1) Place the remote selector switch on the front panel of machine in the remote position. This bypasses the current control on the machine giving the current control to the remote control.



(2) Connect the remote control 9 pin plug from the Tig Torch switch lead to the 9 pin remote receptacle on the front panel of the machine.

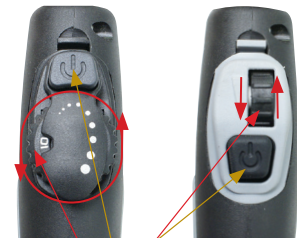

(3) Press the switch to activate the machine. Rotate the amp control potentiometer to select the desired welding current.

Connection and operation of the remote foot control

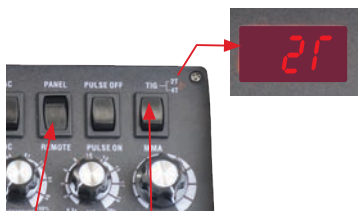

(1) Place the remote selector switch on the front panel of machine in the remote position. (This bypasses the current control on the machine giving the current control to the remote control.) Set Machine to 2T mode.



(2) Connect the remote control 9 pin plug from the remote foot control lead to the 9 pin remote receptacle on the front panel of the machine. (Remote foot control model XA-RFC-3)



(3) Set the dial on the foot control to the desired setting eg - Max = Maximum current output, 50% = 50% of the maximum current output of the machine. Depress the foot pedal to activate the machine, further depressing the pedal will increase the current level to the maximum set by the dial on the foot control.

INSTALLATION SET UP FOR AC TIG WELDING



Set up and operation for AC TIG Welding - XA-TIG200RZ ACDC

- (1) Turn on the machine using the **ON/OFF** switch
- (2) Select the **TIG** function with the **TIG/MMA** selector switch.
- (3) Select **AC** using the **AC/DC** selector switch.
- (4) Connect the **Tig Torch** connector to the **negative terminal** and tighten it.
- (5) Connect the **Earth Cable** connector into the **positive terminal** and tighten it.
- (6) Connect the torch switch remote lead into the torch remote socket
- (7) Insert the torch gas connector into the quick lock gas receptacle.
- (8) Connect gas line to Gas Regulator and connect the gas regulator to the Gas Cylinder.
Carefully open the valve of the gas cylinder, set the flow to 8-12 l/min



INSTALLATION SET UP FOR AC TIG WELDING



continued - Set up and operation for AC TIG Welding - XA-TIG200RZ ACDC

AC (alternating current) enables us to TIG weld non ferrous alloys like Aluminium, Aluminium Alloys and Magnesium. These materials have an insulating surface oxide layer that melts at a higher temperature than the base metal making it difficult to weld the base metal if the oxides are not removed. AC welding current is ideal because the nature of the AC wave form assists in breaking the surface oxide layer. HF arc ignition provides easy and precise starting of the arc, see page 16 for HF start explanation.

- (9) Assemble the front end torch parts use the correct size and type of tungsten electrode for the job.
- (10) Choose **2T** or **4T** trigger function preferred as per the descriptions below
 - 2T** Selection provides 2 times function of the torch switch.
 - (1) Pressing the torch switch gives arc ignition and initializes the welding current and the welding current is maintained by the torch remaining on.
 - (2) Releasing the torch switch stops the welding by introducing down slope and the current falls to minimum level and then terminates the welding current and introduces the post flow gas.
 - 4T** Selection provides 4 times function of the torch switch
 - (1) Pressing the torch switch gives arc ignition and initializes the welding current
 - (2) Releasing the torch switch continues the welding operation.
 - (3) Pressing the torch switch and holding introduces down slope and current falls to minimum current.
 - (4) Releasing the torch switch terminates the welding operation and introduces the post flow gas.
- (11) Choose the preferred welding current (amperage) to suit the tungsten size material type and thickness to be welded.
- (12) Set the AC Balance control to approximately 30%
- (13) Lay the outside edge of the Gas Cup on the work piece with the Tungsten Electrode 1- 3mm from the work piece this method will provide a clean positive arc ignition.
- (14) Press the torch switch and the arc will ignite across the gap between the tungsten and work piece. Hold even distance of about 2mm gap between the tungsten and work piece to maintain the arc.

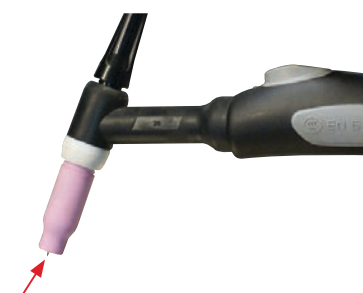

(9) Assemble the front end torch parts use the correct size and type of tungsten electrode for the job, the tungsten electrode requires a sharpened point for DC welding

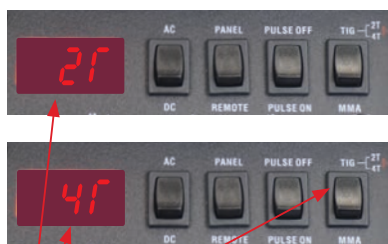

(10) Switch to the TIG function and the machine indicates what mode it is currently on (2T or 4T). To change the mode, switch off to MMA mode and back to TIG. Select 2T or 4T trigger function as required.



(11) Set the Peak Current (amps) to suit the tungsten size material type and thickness to be welded.



(12) Set the AC Balance knob between 4 & 5.



(13) Lay the outside edge of the Gas Cup on the work piece with the Tungsten Electrode 1- 3mm from the work piece



(14) Press the torch switch and the arc will ignite across the gap between the tungsten and work piece. Hold even distance of about 2mm gap between the tungsten and work piece to maintain the arc.

AC (alternating current) enables us to TIG weld non ferrous alloys like Aluminium, Magnesium and Aluminium Alloys. These materials have an insulating surface oxide layer that melts at a higher temperature than the base metal making it difficult to weld the base metal if the oxides are not removed. AC welding current is ideal because the nature of the AC wave form assists in breaking the surface oxide layer.

AC (alternating current) has a current cycle that flows from + (direct) polarity to - (reverse) polarity. The reversing of the polarity breaks the surface oxide while the direct polarity melts the base material.

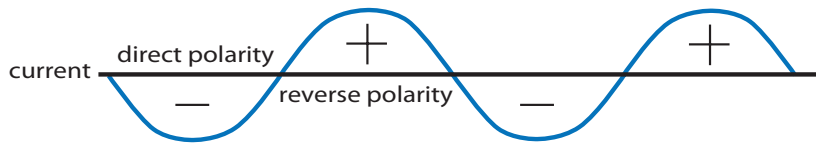

There are inherent problems that come with AC TIG arc rectification, arc stutter, arc wandering and arc stoppage. These problems typically occur during the transition between + and - cycles.

The current is less (30%) during the half of the cycle when the electrode is positive and there is a resistance of the electron flow during this half cycle (rectification). The lack of current flow during this half cycle makes the AC arc unstable.

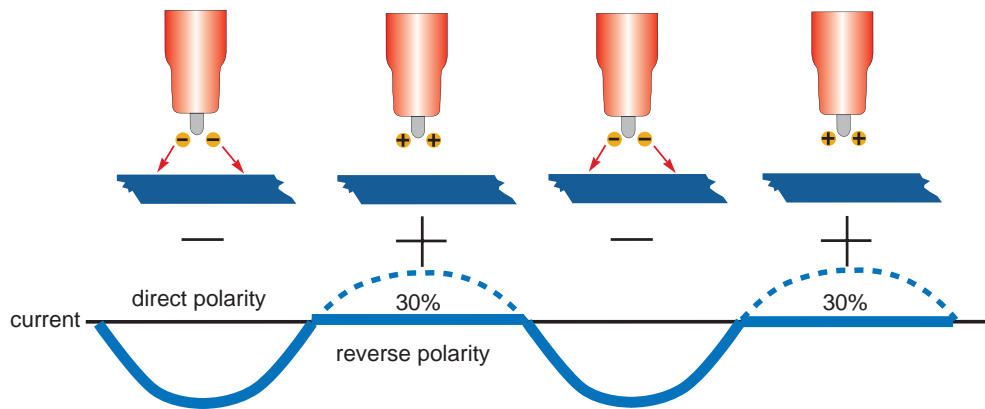

To overcome this lack of flow during one half of the cycle, a high-frequency (HF) voltage is generated and fed into the welding circuit. The HF maintains the arc stability during the half cycle when the electrode is positive.

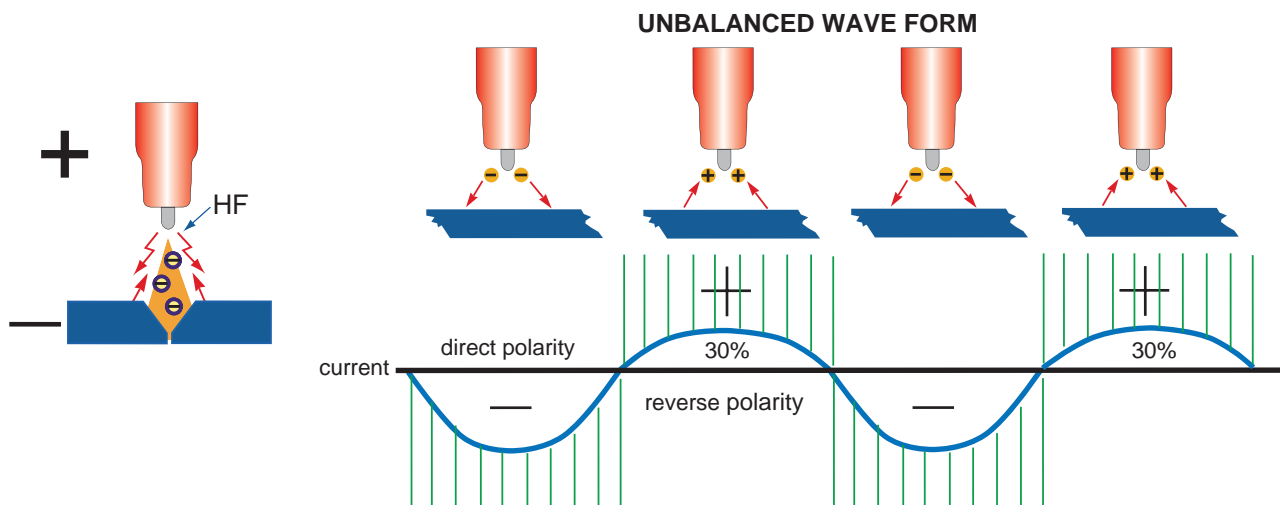

High-frequency voltage flows continually in the welding circuit and keeps the shielding arc in the welding area in an ionized state. When the arc is ionized the arc is maintained during the half of the cycle when the electrode is positive. However while the arc is maintained less current flows during this half of the AC cycle, producing an unbalanced wave.

In older machines, a balanced current output wave was achieved using a large number of capacitors in series or a battery in the welding circuit. Modern TIG power sources use electronics to create and maintain a balanced wave and now most AC TIG power sources produce a square wave current output.

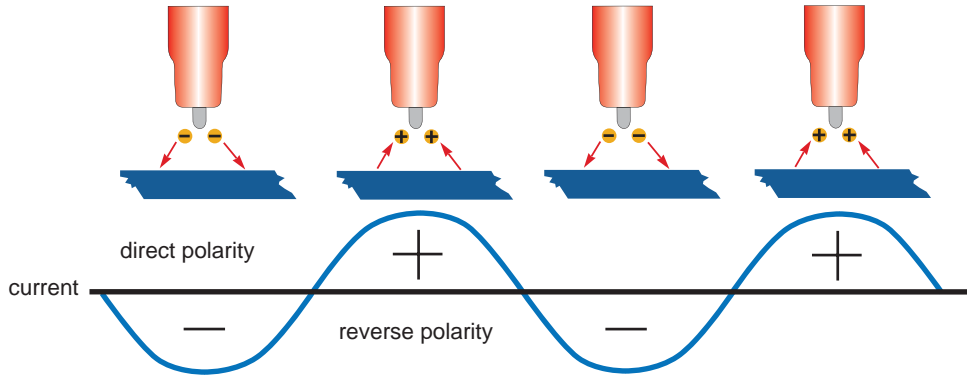

A square wave power supply can change the current from electrode + positive to electrode - negative very quickly. This produces high voltage as the current switches polarities allowing the arc to restart easily. The arc can be maintained without the use of high-frequency or any other arc stabilising methods.

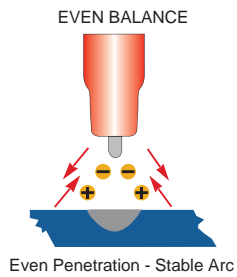

BALANCED SQUARE WAVE FORM

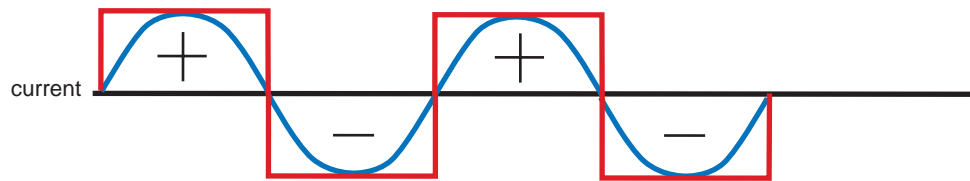

The output current and voltage are controlled electronically so the amount of current electrode positive and the amount of current electrode negative can be adjusted. This allows the welder to adjust the amount of cleaning and the amount of penetration. This is achieved electronically by adjusting the balance control dial on the welding machine. More current flow from the + direct polarity produces stronger arc energy and current flow from the tungsten and is good for removing the oxidized surface of the work piece. However too much + current flow can drive too much energy to the tungsten causing it to overheat and melt the tungsten electrode.

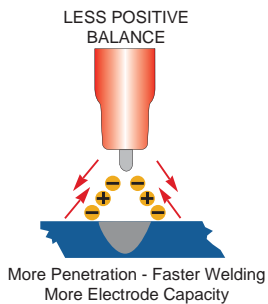

Balance Adjusted for More Penetration - Cooler Tungsten

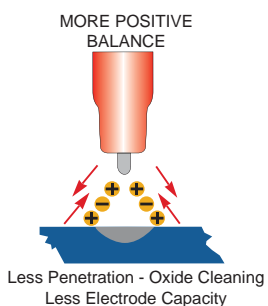
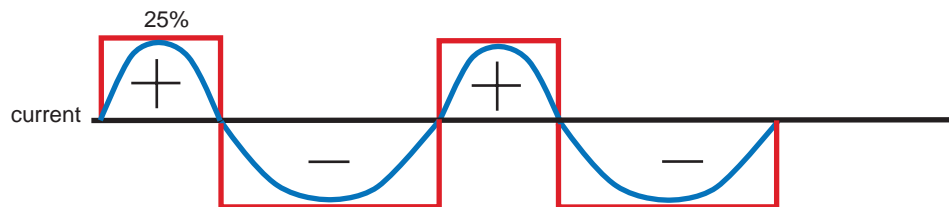

Balance Adjusted for More Oxide Cleansing Action - Hotter Tungsten

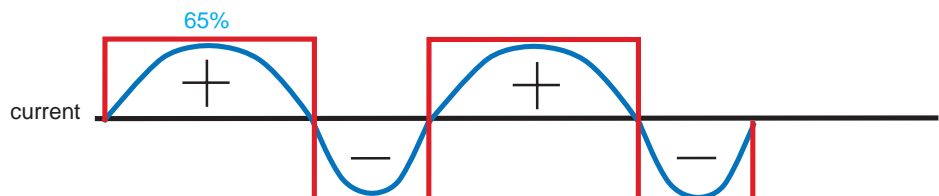

AC WELDING GUIDE



EXAMPLE 1: PULSE AC TIG WELDING - SETUP PARAMETERS:

Material = Aluminium x 3.0mm / Tungsten Electrode = 2.4mm Zirconiated / Gas = Argon

The following steps are a guide as a starting point for you to set the machine up in AC Pulse mode to give an example of welding in AC Pulse TIG function. You can experiment by changing any of the variables to see what effect it has over the welding and what the end result can be, but it is suggested to change only one variable at a time and then check the welding to see what the result is, in this way you acquire a better understanding of how each variable affects the welding current.

- (1) Prepare the machine for AC TIG welding as per the AC TIG operating guide on page
- (2) Set the **Peak Current** at 150 Amps
- (3) Set the **Base Current** around 40% (Base Current is % of the Peak Current eg 40% of 150 = 60 Amps)
- (4) Set the **Pulse Frequency** around 2Hz (pulses per second)

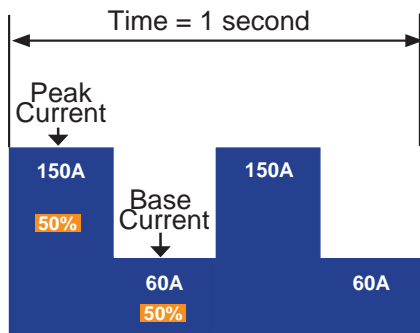

(2) Set the Peak Current at 110 Amps



(3) Set the Base Current at 30%



(4) Set the Pulse Frequency at 2 Hz



(6) Set the Pulse Selector switch to Pulse



Example of Pulsed weld finish

EXAMPLE 2: OF PULSE AC TIG WELDING - SETUP PARAMETERS:

Material = Aluminium x 5.0mm / Tungsten Electrode = 2.4mm Zirconiated / Gas = Argon

- (1) Set the **Peak Current** at 190 Amps
- (2) Set the **Base Current** around 50% (Base Current is % of the Peak Current eg 50% of 190 = 95 Amps)
- (3) Set the **Pulse Frequency** around 1Hz (pulse per second)

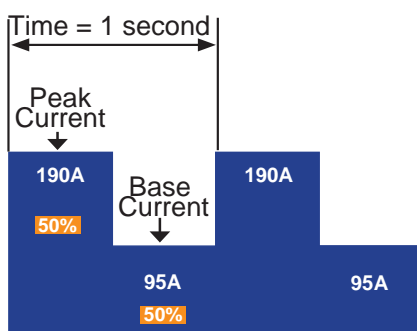

XA26 TIG TORCH & SPARES



XA26 TIG TORCH Suregrip™ Series

180AMP AIR COOLED

Rating: 180A DC, 125AAC @35% duty cycle.

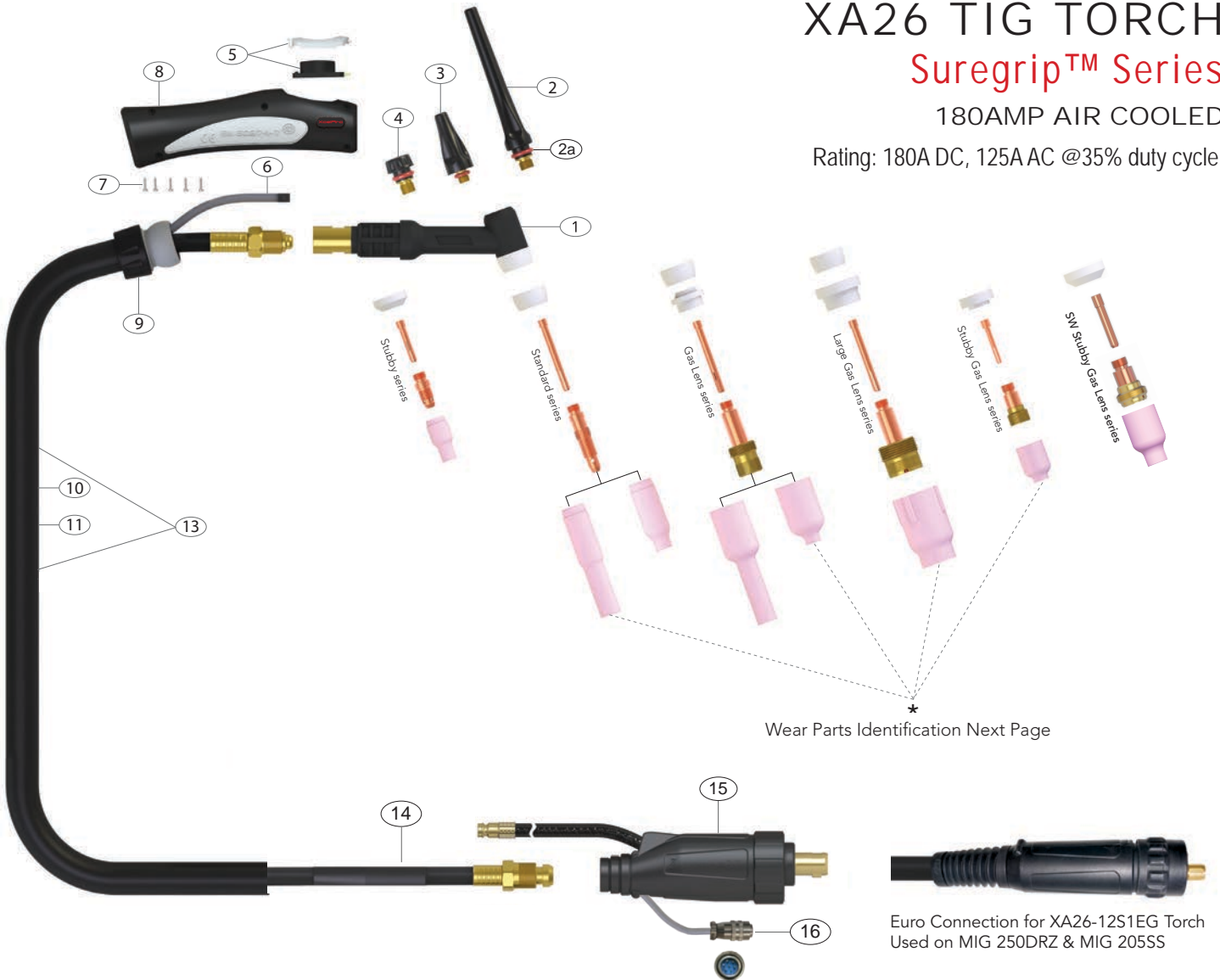

Wear Parts Identification Next Page

Euro Connection for XA26-12S1EG Torch
Used on MIG 250DRZ & MIG 205SS

Torch Model Description	Part Number	
	4m	8m
XA26 Suregrip Tig Torch 4m, Surelok Connector QF Gas	XA26-S112GS4	XA26-S125GS4
XA26FX Suregrip Flexi Tig Torch, Surelok Connector, QF Gas	XA26FX-S112GS4	XA26FX-S125GS4
XA26FX Suregrip Flexi Tig Torch, Euro Connection Style	XA26-12S1EG	XA26-25S1EG

Spare Parts		
Part Number	Description	
1	XA26	Torch Body Standard
	XA26FX	Torch Body Flexible
2	57Y02	Back Cap Long
2a	98W18	Back Cap O Ring
3	57Y05	Back Cap Medium
4	57Y04	Back Cap Short
5	ER1MS	Momentary Switch Kit (See page 174 for Switch options)
6	ERSWL4	Trigger Lead x 4m
	ERSWL8	Trigger Lead x 8m
7	ERSP1	Screw Pack
8	ERH200	Large Ergo Tig Handle

Spare Parts		
Part Number	Description	
9	ERKJ200	Large Knuckle Joint
10	ERLC200-08	Leather Cover x 0.8m
11	ERJK200	Jointing Repair Kit
13	ERCO200-40	Sheath x 4m c/w Leather Cover
	ERCO200-80	Sheath x 8m c/w Leather Cover
14	SL46V28AOB	Power Cable x 4m Surelok OB Rubber
	SL46V30AOB	Power Cable x 8m Surelok OB Rubber
15	UD1025-38	Dinse Tig Power Cable Connector 10-25
	UD3550-38	Dinse Tig Power Cable Connector 35-50
16	C03045	7 Pin Plug

XA26 TIG TORCH & SPARES







Standard Front End Parts

			10N22 Collet 1.0mm		10N30 Collet Body 1.0mm		10N50 Alumina Nozzle Ø 6mm #4		10N49L Long Alumina Nozzle Ø 8mm #5L
18CG Cup Gasket		10N23 Collet 1.6mm	10N31 Collet Body 1.6mm	10N49 Alumina Nozzle Ø 8mm #5	10N48 Alumina Nozzle Ø 10mm #6	10N47 Alumina Nozzle Ø 11mm #7	10N46 Alumina Nozzle Ø 12.5mm #8	10N45 Alumina Nozzle Ø 16mm #10	10N44 Alumina Nozzle Ø 19mm #12
		10N24 Collet 2.4mm	10N32 Collet Body 2.4mm						
		10N25 Collet 3.2mm	10N28 Collet Body 3.2mm						





Stubby Front End Parts

			10N22S Stubby Collet 1.0mm		17CB20 Stubby Collet Body Fits 1.0 - 3.2mm		13N08 Alumina Nozzle Ø 6mm #4		796F70 Long Alumina Nozzle Ø 5mm #3
18CG20 Stubby Cup Gasket		10N23S Stubby Collet 1.6mm	10N23S Stubby Collet 1.6mm	13N09 Alumina Nozzle Ø 8mm #5	13N10 Alumina Nozzle Ø 10mm #6	13N11 Alumina Nozzle Ø 11mm #7	13N12 Alumina Nozzle Ø 13mm #8	13N13 Alumina Nozzle Ø 16mm #10	796F71 Long Alumina Nozzle Ø 6mm #4
		10N24S Stubby Collet 2.4mm	10N24S Stubby Collet 2.4mm						796F72 Long Alumina Nozzle Ø 8mm #5
		10N25S Stubby Collet 3.2mm	10N25S Stubby Collet 3.2mm						796F73 Long Alumina Nozzle Ø 10mm #6



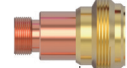

Ultra Stubby Gas Lens Front End Parts

			10N22S Stubby Collet 1.0mm		USTB45V43 Stubby Gas Lens Body 1.6mm		53N58 Gas Lens Nozzle Ø 6mm #4
USTB80300236 Gas Lens Gasket		10N23S Stubby Collet 1.6mm	10N23S Stubby Collet 1.6mm	USTB45V44 Stubby Gas Lens Body 2.4mm	USTB45V45 Stubby Gas Lens Body 3.2mm	53N59 Gas Lens Nozzle Ø 8mm #5	53N60 Gas Lens Nozzle Ø 10mm #6
		10N24S Stubby Collet 2.4mm	10N24S Stubby Collet 2.4mm			53N61 Gas Lens Nozzle Ø 11mm #7	53N61S Gas Lens Nozzle Ø 12.5mm #8
		10N25S Stubby Collet 3.2mm	10N25S Stubby Collet 3.2mm				



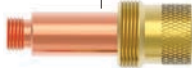

SW Stubby Gas Lens Front End Parts

			10N22S Stubby Collet 1.0mm		45V24S SW Stubby Gas Lens Body 1.0mm		54N16SW Gas Lens Nozzle Ø 10mm #6
18CG20 Stubby Cup Gasket		10N23S Stubby Collet 1.6mm	10N23S Stubby Collet 1.6mm	45V25S SW Stubby Gas Lens Body 1.6mm	45V26S SW Stubby Gas Lens Body 2.4mm	45V27S SW Stubby Gas Lens Body 3.2mm	54N15SW Gas Lens Nozzle Ø 11mm #7
		10N24S Stubby Collet 2.4mm	10N24S Stubby Collet 2.4mm				54N14SW Gas Lens Nozzle Ø 12.5mm #8
		10N25S Stubby Collet 3.2mm	10N25S Stubby Collet 3.2mm				54N12SW Gas Lens Nozzle Ø 16.0mm #10

Gas Lens Front End Parts

			10N22 Collet 1.0mm		45V24 Gas Lens Collet Body 1.0mm		54N18 Long Gas Lens Nozzle Ø 6mm #4L
18CG Cup Gasket	54N01 Gas Lens Gasket	10N23 Collet 1.6mm	10N23 Collet 1.6mm	45V25 Gas Lens Collet Body 1.6mm	45V26 Gas Lens Collet Body 2.4mm	45V27 Gas Lens Collet Body 3.2mm	54N17 Long Gas Lens Nozzle Ø 8mm #5L
		10N24 Collet 2.4mm	10N24 Collet 2.4mm				54N16 Long Gas Lens Nozzle Ø 10mm #6L
		10N25 Collet 3.2mm	10N25 Collet 3.2mm				54N15 Long Gas Lens Nozzle Ø 11mm #7L
							54N14L Long Gas Lens Nozzle Ø 12.5mm #8L

Large Gas Lens Front End Parts

			10N22 Collet 1.0mm		45V0204 Large Gas Lens Body 1.0mm		57N75 Large Gas Lens Nozzle Ø 10mm #6
18CG Cup Gasket	54N63 Large Lens Gasket	10N23 Collet 1.6mm	10N23 Collet 1.6mm	45V116 Large Gas Lens Body 1.6mm	45V64 Large Gas Lens Body 2.4mm	995795 Large Gas Lens Body 3.2mm	57N74 Large Gas Lens Nozzle Ø 12.5mm #8
		10N24 Collet 2.4mm	10N24 Collet 2.4mm				53N88 Large Gas Lens Nozzle Ø 16mm #10
		10N25 Collet 3.2mm	10N25 Collet 3.2mm				53N87 Large Gas Lens Nozzle Ø 19mm #12

GAS FLOW REGULATORS

The job of the gas flow regulator is to reduce the bottle pressure gas down to a lower pressure and deliver it at a constant flow. This constant flow of gas is usually fed through the welding machine where it is controlled by a solenoid valve, operated when the torch trigger is pulled. Once the gas has passed the solenoid valve it flows down the torch cable exiting at the gas nozzle to protect the weld pool and surrounding area. There are two main types of flow regulators commonly used for MIG and TIG welding applications. Both regulator types perform the same function, but have a different way of setting and measuring the gas flow. A flow-gauge regulator (Fig.1) has a dial-type pressure gauge to measure the cylinder contents and a second gauge to measure and deliver the flow rate required. The flow-meter regulator (Fig.2) has a pressure gauge to measure the cylinder contents and a flow tube assembly to measure and deliver the flow rate required. Some flowmeter regulators will have two flow tube assemblies (Fig.3) typically one is used for supplying gas to the welding machine and the other is used for purging the welding area with gas prior to welding, during welding and post welding and at a separate rate of flow from that being supplied to the welding machine. The amount of gas flow needed to do the job will depend on the welding gas and the job being done, but a common setting to start with is 10 L/min.



Fig.1



Fig.2



Fig.3

SHIELDING GASES

Shielding gases are almost always necessary for MIG and TIG welding processes to protect the weld zone from gases that are contained in the surrounding atmosphere, particularly nitrogen and oxygen. If allowed into the weld zone these gases will contaminate the weld pool resulting in fusion defects also porosity and embrittlement of the weld metal. Selecting the right type of shielding gas depends on the welding process being used and type of material being welded. The MIG process is typically a mixture of Argon and Co2 (AR90% Co2 10%) or pure Co2 for steel welding applications, other specialised mixtures of Argon, Co2, and Oxygen are available for stainless steel welding but with welding aluminium pure Argon is almost always used. The TIG welding process almost always requires 100% Argon for welding of all materials, however in some specialised applications Helium, or a Helium mix are sometimes used. Today with the multitude of gas mixes available through a number of different suppliers, it is difficult to list and recommend which gas mix is better for which job. If you are unsure about what gas or gas mix to use we recommend you discuss with your application local gas suppliers or your Esseti technical representative.

MMA (STICK) WELDING TROUBLE SHOOTING



The following chart addresses some of the common problems of MMA welding. In all cases of equipment malfunction, the manufacturer's recommendations should be strictly adhered to and followed.

1: No arc	
Possible Reason	Suggested Remedy
Incomplete welding circuit	Check earth lead is connected. Check all cable connections.
Wrong mode selected	Check the MMA selector switch is selected
No power supply	Check that the machine is switched on and has a power supply
2: Porosity – small cavities or holes resulting from gas pockets in weld metal.	
Possible Reason	Suggested Remedy
Arc length too long	Shorten the arc length
Work piece dirty, contaminated or moisture	Remove moisture and materials like paint, grease, oil, and dirt, including mill scale from base metal
Damp electrodes	Use only dry electrodes
3: Excessive Spatter	
Possible Reason	Suggested Remedy
Amperage too high	Decrease the amperage or choose a larger electrode
Arc length too long	Shorten the arc length
4: Weld sits on top, lack of fusion	
Possible Reason	Suggested Remedy
Insufficient heat input	Increase the amperage or choose a larger electrode
Work piece dirty, contaminated or moisture	Remove moisture and materials like paint, grease, oil, and dirt, including mill scale from base metal
Poor welding technique	Use the correct welding technique or seek assistance for the correct technique
5: Lack of penetration	
Possible Reason	Suggested Remedy
Insufficient heat input	Increase the amperage or choose a larger electrode
Poor welding technique	Use the correct welding technique or seek assistance for the correct technique
Poor joint preparation	Check the joint design and fit up, make sure the material is not too thick. Seek assistance for the correct joint design and fit up
6: Excessive penetration - burn through	
Possible Reason	Suggested Remedy
Excessive heat input	Reduce the amperage or use a smaller electrode
Incorrect travel speed	Try increasing the weld travel speed
7: Uneven weld appearance	
Possible Reason	Suggested Remedy
Unsteady hand, wavering hand	Use two hands where possible to steady up, practise your technique
8: Distortion – movement of base metal during welding	
Possible Reason	Suggested Remedy
Excessive heat input	Reduce the amperage or use a smaller electrode
Poor welding technique	Use the correct welding technique or seek assistance for the correct technique
Poor joint preparation and or joint design	Check the joint design and fit up, make sure the material is not too thick. Seek assistance for the correct joint design and fit up
9: Electrode welds with different or unusual arc characteristic	
Possible Reason	Suggested Remedy
Incorrect polarity	Change the polarity, check the electrode manufacturer for correct polarity

TIG WELDING TROUBLE SHOOTING



The following chart addresses some of the common problems of TIG welding. In all cases of equipment malfunction, the manufacturer's recommendations should be strictly adhered to and followed.

1: Tungsten burning away quickly	
Possible Reason	Suggested Remedy
Incorrect Gas	Check that pure Argon is being used
No gas	Check the gas cylinder contains gas and is connected
Inadequate gas flow	Check the gas is connected, check hoses, gas valve and torch are not restricted. Set the gas flow between 10 - 15 l/min flow rate
Back cap not fitted correctly	Make sure the torch back cap is fitted so that the o-ring is inside the torch body
Torch connected to DC +	Connect the torch to the DC- output terminal
Incorrect tungsten being used	Check and change the tungsten type if necessary
Tungsten being oxidised after weld is finished	Keep shielding gas flowing 10–15 seconds after arc stoppage. 1 second for each 10 amps of weld current.
Tungsten melting back into the nozzle on AC welding	Check that correct type of tungsten is being used. Check the balance control is not set too high on the balance - reduce to a lower setting
2: Contaminated tungsten	
Possible Reason	Suggested Remedy
Touching tungsten into the weld pool	Keep tungsten from contacting weld puddle. Raise the torch so that the tungsten is off of the work piece 2 - 5mm
Touching the filler wire to the tungsten	Keep the filler wire from touching the tungsten during welding, feed the filler wire into the leading edge of the weld pool in front of the tungsten
Tungsten melting into the weld pool	Check that correct type of tungsten is being used. Too much current for the tungsten size so reduce the amps or change to a larger tungsten
3: Porosity - poor weld appearance and colour	
Possible Reason	Suggested Remedy
Incorrect Gas	Check that pure Argon is being used
Inadequate gas flow / gas leaks	Check the gas is connected, check hoses, gas valve and torch are not restricted. Set the gas flow between 10 - 15 l/min flow rate. Check hoses and fittings for holes, leaks etc.,
Moisture on the base metal	Remove all moisture from base metal before welding
Contaminated base metal	Remove materials like paint, grease, oil, and dirt, including mill scale from base metal
Contaminated filler wire	Remove all grease, oil, or moisture from filler metal.
Incorrect filler wire	Check the filler wire and change if necessary
4: Yellowish residue / smoke on the alumina nozzle & discoloured tungsten	
Possible Reason	Suggested Remedy
Incorrect Gas	Use pure Argon gas
Inadequate gas flow	Set the gas flow between 10 - 15 l/min flow rate
Inadequate post flow gas	Increase the post flow gas time
Alumina gas nozzle too small for size of tungsten being used	Increase the size of the alumina gas nozzle
5: Unstable Arc during DC welding	
Possible Reason	Suggested Remedy
Torch connected to DC +	Connect the torch to the DC- output terminal
Contaminated base metal	Remove materials like paint, grease, oil, and dirt, including mill scale from base metal.
Tungsten is contaminated	Remove 10mm of contaminated tungsten and re grind the tungsten
Arc length too long	Lower torch so that the tungsten is off of the work piece 2 - 5mm
Unstable Arc during AC welding	
Incorrect gas or inadequate gas flow	Check that pure Argon is being used. Check the gas is connected, check hoses, gas valve and torch are not restricted. Set the gas flow between 10 - 15 l/min flow rate
Incorrect tungsten being used	Check and change the tungsten type if necessary
Tungsten is contaminated	Remove 10mm of contaminated tungsten and re grind the tungsten
Improperly prepared tungsten	Use a pointed tungsten with AC Squarewave inverter machines. The point will round off after welding.
Excessive rectification in the base metal	Increase balance control. Increase travel speed. Add filler wire during welding

6: HF present but no welding power	
Possible Reason	Suggested Remedy
Incomplete welding circuit	Check earth lead is connected. Check all cable connections. If using a water cooled torch check that the power cable is not separated.
No gas	Check the gas is connected and cylinder valve open, check hoses, gas valve and torch are not restricted. Set the gas flow between 10 - 15 l/min flow rate
Tungsten melting into the weld pool	Check that correct type of tungsten is being used. Too much current for the tungsten size so reduce the amps or change to a larger tungsten
7: Arc wanders during DC welding	
Possible Reason	Suggested Remedy
Poor gas flow	Check and set the gas flow between 10 - 15 l/min flow rate
Incorrect arc length	Lower torch so that the tungsten is off of the work piece 2 - 5mm
Tungsten incorrect or in poor condition	Check that correct type of tungsten is being used. Remove 10mm from the weld end of the tungsten and re sharpen the tungsten
Poorly prepared tungsten	Grind marks should run lengthwise with tungsten, not circular. Use proper grinding method and wheel.
Contaminated base metal	Remove contaminating materials like paint, grease, oil, and dirt, including mill scale from base metal.
Contaminated filler wire	Remove all grease, oil, or moisture from filler metal.
Incorrect filler wire	Check the filler wire and change if necessary
Arc wanders during AC welding	
Possible Reason	Suggested Remedy
Inadequate gas flow	Set the gas flow between 10 - 15 l/min flow rate
Incorrect arc length	Set the torch so that the tungsten is off of the work piece 2 - 5mm
Tungsten is contaminated	Remove 10mm of contaminated tungsten and re grind the tungsten. Use a pointed tungsten with AC Squarewave and inverter machines. The point will round off after welding
Incorrect tungsten size and or tungsten being used	Check and change the size and or the tungsten if required
Excessive rectification in the base metal	Increase balance control. Increase travel speed. Add filler wire during welding
Contaminated base metal	Remove contaminating materials like paint, grease, oil, and dirt, including mill scale from base metal.
8: Arc difficult to start or will not start DC welding	
Possible Reason	Suggested Remedy
Incorrect machine set up	Check machine set up is correct
No gas, incorrect gas flow	Check the gas is connected and cylinder valve open, check hoses, gas valve and torch are not restricted. Set the gas flow between 10 - 15 l/min flow rate
Tungsten is contaminated	Remove 10mm of contaminated tungsten and re grind the tungsten
Incorrect tungsten size and or tungsten being used	Check and change the size and or the tungsten if required
Loose connection	Check all connectors and tighten
Earth clamp not connected to work	Connect the earth clamp directly to the work piece wherever possible
Loss of high frequency	Check torch and cables for cracked insulation or bad connections. Check spark gaps and adjust if necessary
Arc difficult to start or will not start AC welding	
Possible Reason	Suggested Remedy
Incorrect machine set up	Check machine set up is correct
No gas, incorrect gas flow	Check the gas is connected and cylinder valve open, check hoses, gas valve and torch are not restricted. Set the gas flow between 10 - 15 l/min flow rate
Incorrect tungsten size and or tungsten being used	Check and change the size and or the tungsten if required
Tungsten is contaminated	Remove 10mm of contaminated tungsten and re grind the tungsten. Use a pointed tungsten with AC Squarewave and inverter machines. The point will round off after welding
Loose connection	Check all connectors and tighten
Earth clamp not connected to work	Connect the earth clamp directly to the work piece wherever possible
Loss of high frequency	Check torch and cables for cracked insulation or bad connections. Check spark gaps and adjust if necessary

WARRANTY



Thank you for your purchase of your Xcel-Arc TIG200RZ AC/DC Welding Machine.

We are proud of our range of welding equipment that has a proven track record of innovation, performance and reliability.

Our product range represents the latest developments in Inverter technology put together by our professional team of highly skilled engineers. The expertise gained from our long involvement with inverter technology has proven to be invaluable towards the evolution and future development of our equipment range. This experience gives us the inside knowledge on what the arc characteristics, performance and interface between man and machine should be.

Within our team are specialist welders that have a proven history of welding knowledge and expertise, giving vital input towards ensuring that our machines deliver control and performance to the utmost professional level.

We employ an expert team of professional sales, marketing and technical personnel that provide us with market trends, market feedback and customer comments and requirements. Secondly they provide a customer support service that is second to none, thus ensuring our customers have confidence that they will be well satisfied both now and in the future.

Xcel-Arc welders and plasma cutters are manufactured to be compliant with - AS/NZ 60974-1, guaranteeing you electrical safety and performance.

WARRANTY

- 3 Years from date of purchase.
- ESSETI New Zealand Limited warranties all goods as specified by the manufacturer of those goods.
- This Warranty does not cover freight or goods that have been interfered with.
- All goods in question must be repaired by an authorised repair agent as appointed by this company.
- Warranty does not cover abuse, misuse, accident, theft, general wear and tear.
- New product will not be supplied unless ESSETI New Zealand Limited has inspected product returned for warranty and agrees to replace product.
- Product will only be replaced if repair is not possible
- Please view full Warranty term and conditions supplied with machine or at www.XcelArc.nz/warranty-terms/ or at the back of this manual.

ATTENTION! - CHECK FOR GAS LEAKAGE

At initial set up and at regular intervals we recommend to check for gas leakage

Recommended procedure is as follows:

1. Connect the regulator and gas hose assembly and tighten all connectors and clamps.
2. Slowly open the cylinder valve.
3. Set the flow rate on the regulator to approximately 8-10 L/min.
4. Close the cylinder valve and pay attention to the needle indicator of the contents pressure gauge on the regulator, if the needle drops away towards zero there is a gas leak. Sometimes a gas leak can be slow and to identify it will require leaving the gas pressure in the regulator and line for an extended time period. In this situation it is recommended to open the cylinder valve, set the flow rate to 8-10 L/min, close the cylinder valve and check after a minimum of 15 minutes.
5. If there is a gas loss then check all connectors and clamps for leakage by brushing or spraying with soapy water, bubbles will appear at the leakage point.
6. Tighten clamps or fittings to eliminate gas leakage.

IMPORTANT! - We strongly recommend that you check for gas leaks prior to operation of your machine. We recommend that you close the cylinder valve when the machine is not in use.

Esseti NZ Ltd, authorised representatives or agents of Esseti NZ Ltd will not be liable or responsible for the loss of any gas.

ESSETI New Zealand Limited ('us', 'we') warrants that the products bearing the brand names ESSETI, XCEL-ARC, RAZORWELD, RAZORCUT, JASIC, VIPER, T&R, XCEL-GAS, Otos, Servore, TECNA & HIT-8SS supplied by us and purchased by you from an Authorised ESSETI (NZ) Ltd. Distributor are free of Material and Faulty Workmanship Defects except for those products listed under 'Warranty Exclusions' and whilst any claim is made subject to the following terms and conditions.

Your rights under the New Zealand Consumer Law may not be limited by a defined time. However, New Zealand Consumer Law does recognise that the relevant time period can vary from product to product, depending on factors such as the nature of the product and the price. Esseti NZ Ltd. adopts the same approach. As you can appreciate, the type of remedy we can offer you may also vary depending on how long it takes you to return the product to us.

WARRANTY PERIOD

We offer the following 'Warranty Periods' from 'date of purchase':

An Extended Warranty Period of 6 months total shall apply only to Machinery where offered and warranty is registered online.

We offer the following 'Warranty Periods' effective from the 'date of purchase':

XCEL-ARC, Inverter MIG/SWF/MTS, MMA/TIG, TIG ACDC, Plasma (Power Source Only*)	2 Years
RAZORWELD, Inverter MIG/SWF/MTS, MMA/TIG, TIG ACDC (Power Source Only*)	3 Years
RAZORCUT, Inverter Plasma (Power Source Only*)	3 Years
VIPER MIG185, Viper TIG180ACDC (Power Source Only*)	2 Years
VIPER ARC140, VIPER ARC160, VIPER CUT30, (Power Source Only*)	1 Year
VIPER TIG200P, VIPER SYNERGIC MIG 120 (Power Source Only*)	1 Year
JASIC, Inverter MIG/SWF/MTS, MMA/TIG, TIG ACDC, Plasma (Power Source Only*)	2 Years
XCEL-ARC & RAZORWELD, Water Coolers, PAPR Air Blower Unit	1 Year
XCEL-GAS, Gas Cutting and Welding Torches	3 Months
XCEL-GAS, Straight Line & Gas Cutting Machines (Machine Only*)	1 Year
XCEL-GAS, Regulators Argon/ Acetylene / Oxygen / LPG / Bobbin Flowmeter	1 Year
XCEL-ARC, Automatic Welding Helmet	2 Years
RAZORSHIELD Digital Welding Mask & Goggle Kit , Automatic Welding Helmets	2 Year
TECNA, Spot Welding Machines (Power Source Only*)	1 Year
ALL WELDING TORCHES – GMAW / GTAW / MMAW / PLASMA	3 Months
ALL EARTH LEADS, INTERCONNECTING CABLES, GAS HOSES	3 Months

(*) This only covers manufacturing faults on any torches, cables and other accessories, either included with a machine kitset or sold separately, for the first three months after date of purchase.

WARRANTY / RETURNS / EXCHANGES

Our Warranty Returns Policy recognises all and any rights you have under New Zealand Consumer Law and other relevant laws.

You shall inspect the goods on delivery and shall within seven (7) days of delivery (time being of the essence) notify the Esseti NZ Ltd. Authorised Distributor from whom you purchased the goods of any alleged defect, shortage in quantity, damage or failure to comply with the description or quote.

You shall also afford Esseti NZ Ltd. the opportunity to inspect the goods within a reasonable time following delivery if you believe the goods are defective in any way.

If you shall fail to comply with these provisions the goods shall be presumed to be free from any defect or damage. For defective goods and where permissible by law, Esseti NZ Ltd. reserves the right to repair or otherwise remedy the defect prior to issuing replacement goods or refunding the purchase price.

If the goods are being purchased for a business purpose then the purchaser acknowledges that the Consumer Guarantees Act will not apply.

The New Zealand Sales of Goods Act applies when goods are not covered by the Consumer Guarantees Act. You may be able to get a full refund or compensation if the trader doesn't have the right to sell the goods, or the goods are:

- not of 'merchantable quality' (so defective that most people wouldn't want them)
- not fit for their normal purpose
- poorer quality than a sample you were shown
- not suitable for what you told the trader you wanted the goods for
- not matching their description

If there has been a misrepresentation you may have rights under the Fair Trading Act or the Contractual Remedies Act and therefore also entitled to, at the consumer's discretion, either a refund of the purchase price of the goods, or repair of the goods, or replacement of the goods.

Returns will only be accepted provided that:

- (a) You have complied with the provisions outlined above, and
- (b) where the goods are unable to be repaired, the goods are returned at your cost within thirty (30) days of the delivery date, and
- (c) Esseti NZ Ltd. will not be liable for goods which have not been stored or used in a proper manner, and
- (d) the goods are returned in the condition in which they were delivered and with all packaging material, brochures and instructional material in as new condition as is reasonably possible in the circumstances.

Esseti NZ Ltd Accepts no responsibility for any products lost, damaged or mislaid whilst in transit. Esseti NZ Ltd. may (at their sole discretion) accept the return of goods for credit but this may incur a handling fee of up to fifteen percent (15%) of the value of the returned Goods plus any freight costs.

MAKING A CLAIM

If you wish to make a claim under this Warranty, you should:

- Return the product to the point of purchase either in person or via prepaid courier; or
- Contact us by Telephone – Esseti NZ Ltd – 06 355 1103

When returned, the product must be accompanied with the original Receipt or Tax Invoice clearly showing the purchase date and disclosing the purchase price. All costs of installation, cartage, freight, travelling expenses, hiring tools and insurance are paid by the Customer. To the extent permitted by law, our total liability for loss or damage of every kind related to the goods in any way whatsoever is limited to the amount paid to the retailer by you for the goods or the value of the goods. No responsibility will be taken for any products lost, damaged or mislaid whilst in transit.

WARRANTY EXCLUSIONS

This Warranty covers Material and Faulty Workmanship defects only.

This Warranty does not cover damage caused by:

- Normal wear and tear due to usage
- Misuse or abusive use of the machine and/or failure to correctly follow set up or operating instructions supplied with these products
- Failure to clean or improper cleaning of the product
- Failure to maintain the equipment such as regular services, etc.
- Incorrect voltage or non-authorized electrical connections
- Improper installation
- Use of non-authorized/non-standard parts
- Abnormal product performance caused by any ancillary equipment interference or other external factors
- Failure or any breakage caused by overload, dropping or abusive treatment or use by the customer
- Repair, modifications or other work carried out on the product other than by an Esseti-Authorised Service Agent

Unless it is a manufacturing fault, this Warranty does not cover the following parts:

- **All Batteries, including Button Type and Cell Type Batteries**
- **MIG Welding Torch Consumables, such as:**

Gas Nozzles, Gas Diffusers, Contact Tip Holders, Contact Tips, Swan Necks, Triggers, Handles, Liners, Euro Block, Shroud Springs, Knobs, All XCEL-ARC / Magmaweld Mig Welding Wires & Electrodes, Arc Leads, Welding Cable, Electrode Holder, Earth Clamps

- **MMA & TIG Welding Torch Consumables, such as:**

Tungsten Electrodes, Collet, Collet Body, Alumina Nozzle, Torch Head, Torch Head water Cooled, Torch Head Flexible, Back Caps, Gas Lens, Torch Handle, Cup Gasket, Torch Body Gas Valve, O-ring, All XCEL-ARC TIG Welding Rods, All XCEL-ARC / Magmaweld Electrodes, Arc Leads, Welding Cable, Electrode Holder, Earth Clamps

- **PLASMA Cutting Torches Consumables, such as:**

All Cutting Tips, All Diffuser/Swirl Ring, All Electrodes, Retaining Caps, Nozzle Springs, All Spacers, All Shield Caps, All Air and Power Cables, All Switches, All O-rings, All Springs, All Circle Guides and Cutting Kits, Torch Bodies, Air Filter Regulator, Welding Cable, Earth Clamps

- **Gas Welding & Cutting Torch and Straight Line Cutting Machine Consumables and Fittings, such as:**

All Cutting, Welding & Brazing Tips, Adaptors, Hoses, Fittings, Tracks and associated parts

- **Automatic Welding & Cutting Carriage Machine Parts, such as:**

Input Cord, Inter-connecting Power Cord, Triggering Cable

This Warranty does not cover products purchased:

- Without the provision of a suitable Receipt or Tax Invoice that clearly provides proof of purchase as outlined above
- At an auction or from a private seller
- Unless it is a manufacturing fault, this Warranty does not apply to any products sold to Hire Companies.

These conditions may only be varied with the written approval of the Directors of Esseti NZ Limited.

REMEMBER TO RETAIN YOUR ORIGINAL INVOICE FOR PROOF OF PURCHASE.

NOTES



A series of horizontal dotted lines spanning the width of the page, intended for handwritten notes.

NOTES



A series of horizontal dotted lines for taking notes.



Esseti New Zealand Limited
PO Box 4189, Palmerston North - 4442
Phone: 06 355 1103
Fax: (06) 354 2437
Email: sales@esseti.co.nz
www.esseti.co.nz