

RAZORWELD 160/180/200 STICK / TIG WELDERS



OPERATING MANUAL



Please read and understand this instruction manual carefully before the installation and operation of this equipment.

© Xcel-Arc 2021



WARRANTY



Thank you for your purchase of your RAZORWELD ARC Welding Machine.

We are proud of our range of welding equipment that has a proven track record of innovation, performance and reliability.

Our product range represents the latest developments in Inverter technology put together by our professional team of highly skilled engineers. The expertise gained from our long involvement with inverter technology has proven to be invaluable towards the evolution and future development of our equipment range. This experience gives us the inside knowledge on what the arc characteristics, performance and interface between man and machine should be.

Within our team are specialist welders that have a proven history of welding knowledge and expertise, giving vital input towards ensuring that our machines deliver control and performance to the utmost professional level.

We employ an expert team of professional sales, marketing and technical personnel that provide us with market trends, market feedback and customer comments and requirements. Secondly they provide a customer support service that is second to none, thus ensuring our customers have confidence that they will be well satisfied both now and in the future.

Xcel-Arc welders and plasma cutters are manufactured to be compliant with - AS/NZ 60974-1, guaranteeing you electrical safety and performance.

WARRANTY

- 3 Years from date of purchase.
- ESSETI New Zealand Limited warranties all goods as specified by the manufacturer of those goods.
- This Warranty does not cover freight or goods that have been interfered with.
- All goods in question must be repaired by an authorised repair agent as appointed by this company.
- Warranty does not cover abuse, misuse, accident, theft, general wear and tear.
- New product will not be supplied unless ESSETI New Zealand Limited has inspected product returned for warranty and agrees to replace product.
- Product will only be replaced if repair is not possible
- Please view full Warranty term and conditions supplied with machine or at www.XcelArc.nz/warranty-terms/ or at the back of this manual.

ATTENTION! - CHECK FOR GAS LEAKAGE

At initial set up and at regular intervals we recommend to check for gas leakage

Recommended procedure is as follows:

1. Connect the regulator and gas hose assembly and tighten all connectors and clamps.
2. Slowly open the cylinder valve.
3. Set the flow rate on the regulator to approximately 8-10 L/min.
4. Close the cylinder valve and pay attention to the needle indicator of the contents pressure gauge on the regulator, if the needle drops away towards zero there is a gas leak. Sometimes a gas leak can be slow and to identify it will require leaving the gas pressure in the regulator and line for an extended time period. In this situation it is recommended to open the cylinder valve, set the flow rate to 8-10 L/min, close the cylinder valve and check after a minimum of 15 minutes.
5. If there is a gas loss then check all connectors and clamps for leakage by brushing or spraying with soapy water, bubbles will appear at the leakage point.
6. Tighten clamps or fittings to eliminate gas leakage.

IMPORTANT! - We strongly recommend that you check for gas leaks prior to operation of your machine. We recommend that you close the cylinder valve when the machine is not in use.

Esseti NZ Ltd, authorised representatives or agents of Esseti NZ Ltd will not be liable or responsible for the loss of any gas.

WARRANTY.....	2
SAFETY.....	4
RAZORWELD ARC 160 FEATURES.....	7
RAZORWELD ARC 180 FEATURES.....	8
RAZORWELD ARC 200 FEATURES.....	9
MACHINE PARTS LAYOUT.....	10
INSTALLATION SET UP FOR MMA (STICK) WELDING.....	11
MMA(STICK) WELDING GUIDE.....	12
INSTALLATION SET UP FOR DC TIG WELDING.....	15
TIG WELDING GUIDE.....	17
GAS FLOW REGULATORS - SHEILDING GASES.....	21
XA17V TIG TORCH & SPARES.....	22
MMA (STICK) WELDING TROUBLE SHOOTING.....	24
WARRANTY TERMS.....	26



**REGISTER YOUR MACHINE ONLINE TO RECEIVE AN
ADDITIONAL 6 MONTHS ON YOUR WARRANTY**

Visit XcelArc.nz/warranty-registration/ to register your machine.

Welding and cutting equipment can be dangerous to both the operator and people in or near the surrounding working area, if the equipment is not correctly operated. Equipment must only be used under the strict and comprehensive observance of all relevant safety regulations.

Read and understand this instruction manual carefully before the installation and operation of this equipment.

Machine Operating Safety

- Do not switch the function modes while the machine is operating. Switching of the function modes during welding can damage the machine. Damage caused in this manner will not be covered under warranty.
- Disconnect the electrode-holder cable from the machine before switching on the machine, to avoid arcing should the electrode be in contact with the work piece.
- Operators should be trained and or qualified.



Electric shock: It can kill. Touching live electrical parts can cause fatal shocks or severe burns. The electrode and work circuit is electrically live whenever the output is on. The input power circuit and internal machine circuits are also live when power is on. In MIG/MAG welding, the wire, drive rollers, wire feed housing, and all metal parts touching the welding wire are electrically live. Incorrectly installed or improperly grounded equipment is dangerous.

- Connect the primary input cable according to Australian and New Zealand standards and regulations.
- Avoid all contact with live electrical parts of the welding/cutting circuit, electrodes and wires with bare hands.
- The operator must wear dry welding gloves while he/she performs the welding/cutting task.
- The operator should keep the work piece insulated from himself/herself.
- Keep cords dry, free of oil and grease, and protected from hot metal and sparks.
- Frequently inspect input power cable for wear and tear, replace the cable immediately if damaged, bare wiring is dangerous and can kill.
- Do not use damaged, under sized, or badly joined cables.
- Do not drape cables over your body.
- We recommend (RCD) safety switch is used with this equipment to detect any leakage of current to earth.



Fumes and gases are dangerous. Smoke and gas generated whilst welding or cutting can be harmful to people's health. Welding produces fumes and gases. Breathing these fumes and gases can be hazardous to your health.

Do not breathe the smoke and gas generated whilst welding or cutting, keep your head out of the fumes

- Keep the working area well ventilated, use fume extraction or ventilation to remove welding/cutting fumes and gases.
- In confined or heavy fume environments always wear an approved air-supplied respirator.
- Welding/cutting fumes and gases can displace air and lower the oxygen level causing injury or death. Be sure the breathing air is safe.
- Do not weld/cut in locations near de-greasing, cleaning, or spraying operations. The heat and rays of the arc can react with vapours to form highly toxic and irritating gases.
- Materials such as galvanized, lead, or cadmium plated steel, containing elements that can give off toxic fumes when welded/cut. Do not weld/cut these materials unless the area is very well ventilated, and or wearing an air supplied respirator.



Arc rays: harmful to people's eyes and skin. Arc rays from the welding/cutting process produce intense visible and invisible ultraviolet and infrared rays that can burn eyes and skin.

Always wear a welding helmet with correct shade of filter lens and suitable protective clothing including welding gloves whilst the welding/cutting operation is performed.

- Measures should be taken to protect people in or near the surrounding working area. Use protective screens or barriers to protect others from flash, glare and sparks; warn others not to watch the arc.



Fire hazard. Welding/cutting on closed containers, such as tanks, drums, or pipes, can cause them to explode. Flying sparks from the welding/cutting arc, hot work piece, and hot equipment can cause fires and burns. Accidental contact of electrode to metal objects can cause sparks, explosion, overheating, or fire. Check and be sure the area is safe before doing any welding/cutting.

- The welding/cutting sparks & spatter may cause fire, therefore remove any flammable materials well away from the working area. Cover flammable materials and containers with approved covers if unable to be moved from the welding/cutting area.
- Do not weld/cut on closed containers such as tanks, drums, or pipes, unless they are properly prepared according to the required Safety Standards to insure that flammable or toxic vapours and substances are totally removed, these can cause an explosion even though the vessel has been "cleaned". Vent hollow castings or containers before heating, cutting or welding. They may explode.
- Do not weld/cut where the atmosphere may contain flammable dust, gas, or liquid vapours (such as petrol)
- Have a fire extinguisher nearby and know how to use it. Be alert that welding/cutting sparks and hot materials from welding/cutting can easily go through small cracks and openings to adjacent areas. Be aware that welding/cutting on a ceiling, floor, bulkhead, or partition can cause fire on the hidden side.



Gas Cylinders. Shielding gas cylinders contain gas under high pressure. If damaged, a cylinder can explode. Because gas cylinders are normally part of the welding/cutting process, be sure to treat them carefully. CYLINDERS can explode if damaged.

- Protect gas cylinders from excessive heat, mechanical shocks, physical damage, slag, open flames, sparks, and arcs.
- Insure cylinders are held secure and upright to prevent tipping or falling over.
- Never allow the welding/cutting electrode or earth clamp to touch the gas cylinder, do not drape welding cables over the cylinder.
- Never weld/cut on a pressurised gas cylinder, it will explode and kill you.
- Open the cylinder valve slowly and turn your face away from the cylinder outlet valve and gas regulator.



Gas build up. The build up of gas can causes a toxic environment, deplete the oxygen content in the air resulting in death or injury. Many gases use in welding/cutting are invisible and odourless.

- Shut off shielding gas supply when not in use.
- Always ventilate confined spaces or use approved air-supplied respirator.



Electronic magnetic fields. MAGNETIC FIELDS can affect Implanted Medical Devices.

- Wearers of Pacemakers and other Implanted Medical Devices should keep away.
- Implanted Medical Device wearers should consult their doctor and the device manufacturer before going near any electric welding, cutting or heating operation.



Noise can damage hearing. Noise from some processes or equipment can damage hearing.

- Wear approved ear protection if noise level is high.



Hot parts. Items being welded/cut generate and hold high heat and can cause severe burns.

Do not touch hot parts with bare hands. Allow a cooling period before working on the welding/cutting gun. Use insulated welding gloves and clothing to handle hot parts and prevent burns.

CAUTION

1. Working Environment.

- i. The environment in which this welding/cutting equipment is installed must be free of grinding dust, corrosive chemicals, flammable gas or materials etc, and at no more than maximum of 80% humidity.
- ii. When using the machine outdoors protect the machine from direct sun light, rain water and snow etc; the temperature of working environment should be maintained within -10°C to +40°C.
- iii. Keep this equipment 30cm distant from the wall.
- iv. Ensure the working environment is well ventilated.

2. Safety Tips.

i. Ventilation

This equipment is small-sized, compact in structure, and of excellent performance in amperage output. The fan is used to dissipate heat generated by this equipment during the welding/cutting operation. Important: Maintain good ventilation of the louvres of this equipment. The minimum distance between this equipment and any other objects in or near the working area should be 30 cm. Good ventilation is of critical importance for the normal performance and service life of this equipment.

ii. Thermal Overload protection.

Should the machine be used to an excessive level, or in high temperature environment, poorly ventilated area or if the fan malfunctions the Thermal Overload Switch will be activated and the machine will cease to operate. Under this circumstance, leave the machine switched on to keep the built-in fan working to bring down the temperature inside the equipment. The machine will be ready for use again when the internal temperature reaches safe level.

iii. Over-Voltage Supply

Regarding the power supply voltage range of the machine, please refer to "Main parameter" table. This equipment is of automatic voltage compensation, which enables the maintaining of the voltage range within the given range. In case that the voltage of input power supply amperage exceeds the stipulated value, it is possible to cause damage to the components of this equipment. Please ensure your primary power supply is correct.

- iv. Do not come into contact with the output terminals while the machine is in operation. An electric shock may possibly occur.

MAINTENANCE

Exposure to extremely dusty, damp, or corrosive air is damaging to the welding/cutting machine. In order to prevent any possible failure or fault of this welding/cutting equipment, clean the dust at regular intervals with clean and dry compressed air of required pressure.

Please note that: lack of maintenance can result in the cancellation of the guarantee; the guarantee of this welding/cutting equipment will be void if the machine has been modified, attempt to take apart the machine or open the factory-made sealing of the machine without the consent of an authorized representative of the manufacturer.

TROUBLE SHOOTING

Caution: Only qualified technicians are authorized to undertake the repair of this welding/cutting equipment. For your safety and to avoid Electrical Shock, please observe all safety notes and precautions detailed in this manual.

Note:

Minimum Motor Generator Power Suggested

ARC160PFC :- 7.0KVA

ARC160PFC :- 10.0KVA

INSTALLATION & OPERATION

Please install the machine strictly according to the steps. The protection class of this machine is IP21S, so avoid using it in rain.

CONNECTION OF INPUT CABLES

Primary input cable is supplied with this welding equipment. Connect the primary input cable with power supply of required input voltage. Refer to data plate on machine for Input voltage, IMAX and IEFF.

EMC DECLARATION

IEC 60974-10:2007

Arc Welding equipment - Part 10: Electromagnetic compatibility (EMC) requirements (Classification of ISM Equipment - According to IEC 60974-10:2007 and CISPR 11: 2033+A1:2004 Clause 4.1 and 4.2. The EUT Belongs to Apparatus Group2 Class A)

RAZORWELD ARC 160 FEATURES

RazorWeld

Welds: Steels, Stainless, Cast Iron, Bronze, Copper

RAZORWELD ARC160

230V Single Phase 160 Amp DC Welder MMA/TIG
Latest 40KHz Inverter, PFC & Selectable VRD
Approved Domestic 10 Amp Plug



Features

- New 40KHz inverter frequency technology
- PFC Power Factor Correction (for maximum electrical efficiency)
- MMA (stick electrode)
 - Selectable On/Off VRD (Voltage Reduction Device)
 - Hot start (improves electrode starting)
 - Arc Force (boosts current to prevent electrode extinguishing)
 - Excellent arc stability with all electrodes
- DC-TIG
 - Lift Arc ignition (prevents tungsten sticking during arc ignition)
 - Ultra smooth DC-TIG welding current
- Thermal overload protection
- Generator compatible (recommend 7.5 kVA minimum)
- Tolerant to variable power supply



XA-ARC160RZ-K
Standard Package



Optional machine accessories available - refer www.xcelarc.nz

Technical Data

Power Supply	240V 1-Phase $\pm 15\%$
Rated Input Power	7.1 kVA
I _{eff} as per AS/NZ60974-1	10.0 Amps
Rated Output MMA	160 Amps / 26.4V
Rated Output TIG	160 Amps / 16.4V
Welding Current Range	10 ~ 160 Amps
No Load Voltage (OCV)	VRD On 9V - VRD Off 77V
Duty Cycle @ 40°C as per AS/NZ60974-1	20% @ 160 Amps MMA 45% @ 160 Amps TIG
Duty Cycle @ 25°C (approximate)	40% @ 160 Amps MMA 80% @ 160 Amps TIG
Efficiency	85%
Power Factor	0.99
Protection Class	IP21S
Insulation Class	F
Dimensions (LxWxH)	365 x 135 x 227mm
Weight	6.5 kg
Certification Approval	AS/NZ60974-1

Overview

The RazorWeld ARC160PFC from Xcel-Arc is a high quality inverter welding machine with a primary function of DC-MMA (Stick) welding and additional DC-TIG function incorporating Lift-Arc Ignition. Produced using the very latest generation 40KHz IGBT inverter technology; this machine offers outstanding arc characteristics whilst also being highly reliable, robust and with the added benefit of being factory-fitted with a domestic 10 Amp plug with NZ Standards approval. The DC-MMA welding function delivers a smooth and incredibly stable arc, producing high quality welds including cast Iron, stainless and low hydrogen. With the inclusion of both Hot-Start and automatic Arc Force coupled with Selectable **VRD and Power Factor Correction (PFC)**, this machine is perfectly suited to site work for use with most electrodes up to 4.0mm diameter. Connection of the optional XA17V Tig Torch provides intermediate level DC-TIG welding of steel, stainless steel, bronze and copper. The Lift-Arc TIG function delivers perfect arc ignition every time without any sticking or inclusion of the tungsten electrode to the work and a remarkably smooth stable arc produces high quality TIG welds. The ARC160RZ is an exceptional machine suitable for a wide range of applications including light to medium industrial use, site welding, farming and general repair and maintenance work. The ARC160PFC gives you great portability with the power to get the job done. Built to our specification and manufactured in compliance to AS/NZ60974-1.

Product Code: XA-ARC160RZ-K

Standard Package includes: ARC160PFC Machine, Earth Lead & Arc Lead 25mm x 4m

RAZORWELD ARC 180 FEATURES



Welds: Steels, Stainless, Cast Iron, Bronze, Copper

RAZORWELD ARC180

230V Single Phase 180 Amp DC Welder MMA/TIG
Selectable VRD - Increased Workplace Safety
Industrial Rated 40KHz Inverter



Features

- New 40KHz inverter frequency technology
- MMA (stick electrode)
 - Selectable On/Off VRD (Voltage Reduction Device)
 - Hot start (improves electrode starting)
 - Arc Force (boosts current to prevent electrode extinguishing)
 - Excellent arc stability with all electrodes
- DC-TIG
 - Lift Arc ignition (prevents tungsten sticking during arc ignition)
 - Ultra smooth DC-TIG welding current
- Thermal overload protection
- Generator compatible (recommend 8.5 kVA minimum)
- Tolerant to variable power supply



Technical Data

Power Supply	240V 1-Phase $\pm 15\%$
Rated Input Power	8.2 kVA
I_{eff} as per AS/NZ60974-1	15.3 Amps
Rated Output MMA	180 Amps / 27.2V
Rated Output TIG	180 Amps / 17.2V
Welding Current Range	10 ~ 180 Amps
No Load Voltage (OCV)	VRD On 9V - VRD Off 77V
Duty Cycle @ 40°C as per AS/NZ60974-1	20% @ 180 Amps MMA 50% @ 180 Amps TIG
Duty Cycle @ 25°C (approximate)	50% @ 180 Amps MMA 80% @ 180 Amps TIG
Efficiency	85%
Power Factor	0.70
Protection Class	IP21S
Insulation Class	F
Dimensions (LxWxH)	313 x 130 x 250mm
Weight	4.7 kg
Certification Approval	AS/NZ60974-1

XA-ARC180RZ-K
Standard Package



Optional machine accessories available - www.xcelarc.nz

Overview

The RazorWeld ARC180 from Xcel-Arc is a high quality inverter welding machine with a primary function of DC-MMA (Stick) welding and additional DC-TIG function incorporating Lift-Arc Ignition. Produced using the very latest generation 40KHz IGBT inverter technology; this machine offers outstanding arc characteristics whilst also being highly reliable, robust and incredibly portable. The DC-MMA welding function delivers a smooth and incredibly stable arc, producing high quality welds including cast Iron, stainless and low hydrogen. With the inclusion of both Hot-Start and automatic Arc Force coupled with Selectable VRD for increased workplace safety, this machine is suited to site work and a popular choice for the general engineer or contractor. With connection of the optional XA17V Tig Torch, this machine also provides intermediate level DC-TIG welding of steel, stainless steel, bronze and copper. The Lift-Arc TIG function is superb and delivers perfect arc ignition every time without any sticking or inclusion of the tungsten electrode to the work piece and a remarkably smooth stable arc produces high quality TIG welds. The ARC180RZ is an exceptional machine suitable for a wide range of applications including medium-level industrial use, site welding, farming and general repair and maintenance work. The ARC180RZ gives you great portability with the power to get the job done. Built to our specification and manufactured in compliance to AS/NZ60974-1.

Product Code: XA-ARC180RZ-K

Standard Package includes: XA-ARC180RZ Machine, Earth Lead & Arc Lead 25mm x 4m, Heavy Duty Safe Carry Case

RAZORWELD ARC 200 FEATURES

RazorWeld

Welds: Steels, Stainless, Cast Iron, Bronze, Copper

RAZORWELD ARC200

230V Single Phase 200 Amp DC Welder MMA/TIG
Selectable VRD - Stick Electrode, Lift Arc DC TIG
Industrial Rated with PFC (Power Factor Correction)



Features

- New 40KHz inverter frequency technology
- PFC (Power Factor Correction) for maximum electrical efficiency
- MMA function (Stick electrode)
 - Selectable On/Off VRD (Voltage Reduction Device)
 - Hot start (improves electrode starting)
 - Arc Force (boosts current to prevent electrode extinguishing)
 - Excellent arc stability with all electrodes
- DC-TIG
 - Lift Arc ignition (prevents tungsten sticking during arc ignition)
 - Ultra smooth DC-TIG welding current
- Thermal overload protection
- IP21S rating for environmental/safety protection
- Generator compatible (recommend 9.0 kVA minimum)
- Auto-compensation for voltage fluctuation
- Minimal harmonic feedback to power grid

XA-ARC200RZ-K
Standard Package



Optional machine accessories available - www.xcelarc.nz

Technical Data

Power Supply	240V 1-Phase $\pm 15\%$
Rated Input Power	9.0 kVA
Efficiency as per AS/NZ60974-1	15 Amps
Rated Output	200 Amps / 28V MMA 200 Amps / 18V TIG
Welding Current Range	10 ~ 200 Amps
No Load Voltage (OCV)	VRD On 9V - Off 77V
Duty Cycle @ 40°C as per AS/NZ60974-1	25% @ 200 Amps MMA 25% @ 200 Amps TIG
Duty Cycle @ 25°C (approximate)	40% @ 200 Amps MMA 40% @ 200 Amps TIG
Power Factor	0.99
Protection Class	IP21S
Insulation Class	F
Dimensions (LxWxH)	365 x 135 x 227mm
Weight	6.5 kg
Certification Approval	AS/NZ60974-1

Overview

The RazorWeld ARC200 from Xcel-Arc is a high quality inverter welding machine with a primary function of DC-MMA (Stick) welding and additional DC-TIG function incorporating Lift-Arc Ignition. Produced using the very latest generation 40KHz IGBT inverter technology; this machine offers outstanding arc characteristics whilst also being highly reliable, robust and incredibly portable. The DC-MMA welding function delivers a smooth and incredibly stable arc, producing high quality welds including cast Iron, stainless and low hydrogen. With the inclusion of Hot-Start and Arc Force coupled with Selectable **VRD and Power Factor Correction (PFC)**, this machine is perfectly suited to site work and is an ideal choice for the welding professional or contractor. Connection of the optional XA17V Tig Torch provides intermediate level DC-TIG welding of steel, stainless steel, bronze and copper. The Lift-Arc TIG function is superb and delivers perfect arc ignition every time without any sticking or inclusion of the tungsten electrode to the work piece and a remarkably smooth stable arc produces high quality TIG welds. The ARC200RZ is an exceptional machine suitable for a wide range of applications including medium to heavy industrial use, site welding, farming and general repair and maintenance work. The ARC200RZ gives you great portability with the power to get the job done. Built to our specification and manufactured in compliance to AS/NZ60974-1.

Product Code: XA-ARC200RZ-K

Standard Package includes: ARC200RZ Machine, Earth Lead & Arc Lead 25mm x 4m

FRONT PANEL MACHINE LAYOUT:



REAR PANEL MACHINE LAYOUT:



RazorWeld
ARC160-180-200



INSTALLATION SET UP FOR MMA (STICK) WELDING



- (1) Turn the power source on and select the **MMA** function with the Tig/MMA selector switch.
- (2) **Connection of Output Cables:** Various electrodes require a different polarity for optimum results refer to the electrode manufacturers information for the correct polarity. Most GP electrodes are Electrode connected to \ominus output socket, Earth Connected to the \oplus output socket
- (3) Set the welding current relevant to the electrode type and size being used as recommended by the electrode manufacturer.
- (4) Place the electrode into the electrode holder and clamp tight
- (5) Strike the electrode on the work to create the arc and hold the electrode steady to maintain the arc
- (6) Hold the electrode slightly above the work piece to maintain the arc while travelling at an even speed to create and even weld deposition
- (7) To finish the weld, break the arc by quickly snapping the electrode away from the work piece.
- (8) Wait for the weld to cool and carefully chip away the slag to reveal the weld metal underneath



(3) Set the welding current using the amperage control dial



4) Place the electrode into the electrode holder and clamp tight.



5) Strike the electrode against the work piece to create and arc and hold the electrode steady to maintain the arc



6) Hold the electrode slightly above the work maintaining the arc while travelling at an even speed.

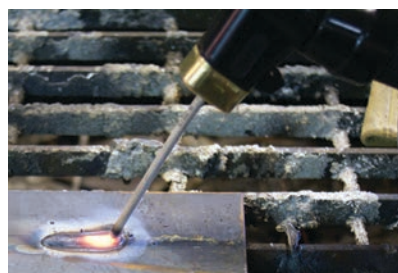

7) To finish the weld, break the arc by quickly snapping the electrode away from the work piece.

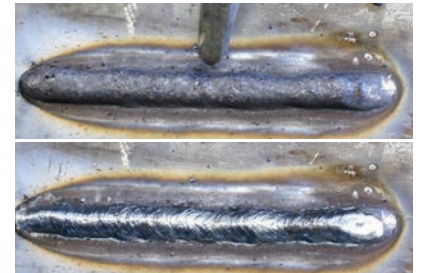

8) Wait for the weld to cool and carefully chip away the slag to reveal the weld metal below.

MMA(STICK) WELDING GUIDE

VRD - What is it and what does it do?

VRD is short for Voltage Reduction Device and it is a Safety Feature of the welding machine. VRD reduces the welding power source's open circuit voltage (OCV). OCV is the voltage measured between the terminals when not welding. The VRD function will activate welding power when the electrode is in contact with the work piece and the resistance between the electrode and work is less than 200 Ohms. This means that the chance of being electrocuted from the secondary welding circuit has virtually been eliminated in situations where the operator is in contact with the electrode and the workpiece at the same time. In damp, wet and humid environments the chance of electric shock from the secondary welding to the operator is increased, in particular if the operator is not wearing protective leather welding gloves.

VRD can make the arc ignition of some electrodes more difficult especially for the inexperienced operator. Switchable VRD allows the VRD function to be switched off thereby increasing the OCV and providing extra energy to establish the arc at the electrode.

Switchable VRD is controlled by a key switch at the rear of the machine and is in accordance with AS/NZS 1674.2 2003. It allows the VRD function to be locked ON by the work place supervisor in those workplace environments where VRD operation is required.

SWITCHABLE VRD OPERATION:



MMA(STICK) WELDING GUIDE



MMA (Manual Metal Arc) Welding

One of the most common types of arc welding is manual metal arc welding (MMA) or stick welding. An electric current is used to strike an arc between the base material and a consumable electrode rod or 'stick'. The electrode rod is made of a material that is compatible with the base material being welded and is covered with a flux that gives off gaseous vapours that serve as a shielding gas and providing a layer of slag, both of which protect the weld area from atmospheric contamination. The electrode core itself acts as filler material the residue from the flux that forms a slag covering over the weld metal must be chipped away after welding.

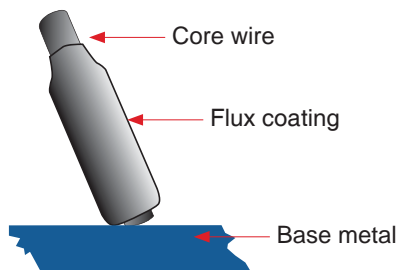
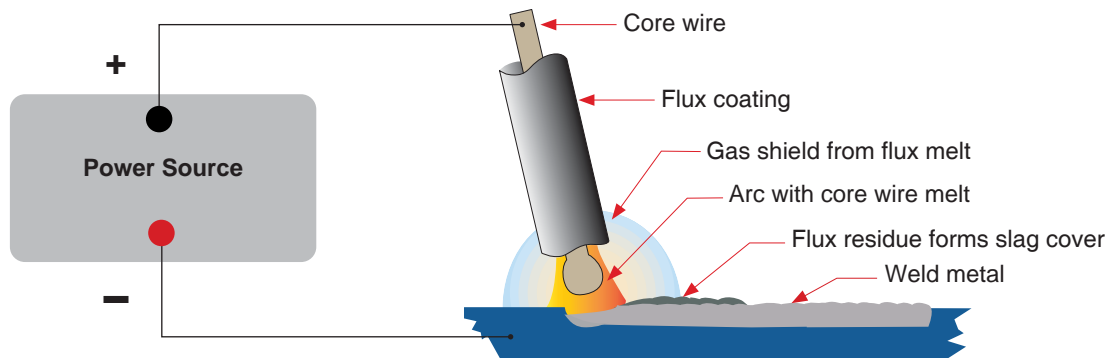

- The arc is initiated by momentarily touching the electrode to the base metal.
- The heat of the arc melts the surface of the base metal to form a molten pool at the end of the electrode.
- The melted electrode metal is transferred across the arc into the molten pool and becomes the deposited weld metal.
- The deposit is covered and protected by a slag which comes from the electrode coating.
- The arc and the immediate area are enveloped by an atmosphere of protective gas

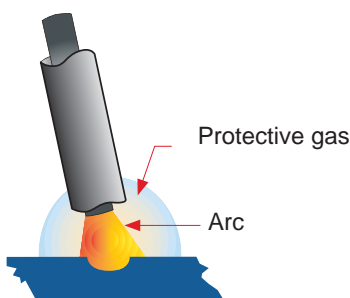

Manual metal arc (stick) electrodes have a solid metal wire core and a flux coating. These electrodes are identified by the wire diameter and by a series of letters and numbers. The letters and numbers identify the metal alloy and the intended use of the electrode.

The **Metal Wire Core** works as conductor of the current that maintains the arc. The core wire melts and is deposited into the welding pool.

The covering on a shielded metal arc welding electrode is called **Flux**. The flux on the electrode performs many different functions. These include:

- producing a protective gas around the weld area
- providing fluxing elements and deoxidizers
- creating a protective slag coating over the weld as it cools
- establishing arc characteristics
- adding alloying elements.

Covered electrodes serve many purposes in addition to adding filler metal to the molten pool. These additional functions are provided mainly by the covering on the electrode.

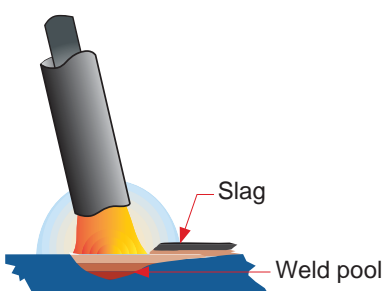

MMA (Stick) Welding Fundamentals

Electrode Selection

As a general rule, the selection of an electrode is straight forward, in that it is only a matter of selecting an electrode of similar composition to the parent metal. However, for some metals there is a choice of several electrodes, each of which has particular properties to suit specific classes of work. It is recommended to consult your welding supplier for the correct selection of electrode.

Electrode Size

Average Thickness of Material	Maximum Recommended Electrode Diameter
1.0 - 2.0mm	2.5mm
2.0 - 5.0mm	3.2mm
5.0 - 8.0mm	4.0mm
8.0 - > mm	5.0mm

The size of the electrode generally depends on the thickness of the section being welded, and the thicker the section the larger the electrode required. The table gives the maximum size of electrodes that may be used for various thicknesses of section based on using a general purpose type 6013 electrode.

Welding Current (Amperage)

Electrode Size \varnothing mm	Current Range (Amps)
2.5mm	60 - 95
3.2mm	100 - 130
4.0mm	130 - 165
5.0mm	165 - 260

Correct current selection for a particular job is an important factor in arc welding. With the current set too low, difficulty is experienced in striking and maintaining a stable arc. The electrode tends to stick to the work, penetration is poor and beads with a distinct rounded profile will be deposited. Too high current is accompanied by overheating of the electrode resulting in undercut and burning through of the base metal and producing

excessive spatter. Normal current for a particular job may be considered as the maximum, which can be used without burning through the work, overheating the electrode or producing a rough spattered surface. The table shows current ranges generally recommended for a general purpose type 6013 electrode.

Arc Length

To strike the arc, the electrode should be gently scraped on the work until the arc is established. There is a simple rule for the proper arc length; it should be the shortest arc that gives a good surface to the weld. An arc too long reduces penetration, produces spatter and gives a rough surface finish to the weld. An excessively short arc will cause sticking of the electrode and result in poor quality welds. General rule of thumb for down hand welding is to have an arc length no greater than the diameter of the core wire.

Electrode Angle

The angle that the electrode makes with the work is important to ensure a smooth, even transfer of metal. When welding in down hand, fillet, horizontal or overhead the angle of the electrode is generally between 5 and 15 degrees towards the direction of travel. When vertical up welding the angle of the electrode should be between 80 and 90 degrees to the work piece.

Travel Speed

The electrode should be moved along in the direction of the joint being welded at a speed that will give the size of run required. At the same time, the electrode is fed downwards to keep the correct arc length at all times. Excessive travel speeds lead to poor fusion, lack of penetration etc, while too slow a rate of travel will frequently lead to arc instability, slag inclusions and poor mechanical properties.

Material and Joint Preparation

The material to be welded should be clean and free of any moisture, paint, oil, grease, mill scale, rust or any other material that will hinder the arc and contaminate the weld material. Joint preparation will depend on the method used include sawing, punching, shearing, machining, flame cutting and others. In all cases edges should be clean and free of any contaminants. The type of joint will be determined by the chosen application.



INSTALLATION SET UP FOR DC TIG WELDING

- (1) Switch on the machine, select the **TIG** function with the Tig/MMA selector switch.
- (2) Insert the power cable plug of the Tig torch into the **Negative** socket on the front of the machine and tighten it.
- (3) Insert the earth cable plug into the **Positive** socket on the front of the machine and tighten it.
- (4) Connect the gas line of the Tig torch to regulator and connect the regulator to the gas cylinder.



(1) Set Tig/MMA selector switch to TIG

(3) Connect earth lead to ⊕

(4) Connect the gas line to the regulator and connect to the gas cylinder

(2) Connect the TIG torch cable connector to ⊖



(5) Assemble front end parts of the TIG torch, fitting a sharpened tungsten suitable for DC welding.



(6) Carefully open the valve of the gas cylinder, set the l/min to 6-12



(7) Set the welding current using the amperage control dial

LIFT ARC DC TIG OPERATION



Lift Arc ignition allows the arc to be started easily in DC Tig by simply touching the tungsten to the work piece and lifting it up to start the arc. This prevents the tungsten tip sticking to the work piece and breaking the tip from the tungsten electrode. There is a particular technique called “rocking the cup” used in the Lift Arc process that provides easy use of the Lift Arc function.

- (5) Make sure the front end parts of the tig torch are correctly assembled, use the correct size and type of tungsten electrode for the job, the tungsten electrode requires a sharpened point for DC welding.
- (6) Turn on the Gas Valve located on the tig torch handle.
- (7) Lay the outside edge of the Gas Cup on the work piece with the Tungsten Electrode 1- 2mm from the work piece.
- (8) With a small movement rotate the Gas Cup forward so that the Tungsten Electrode touches the work piece.
- (9) Now rotate the Gas Cup in the reverse direction to lift the Tungsten electrode from the work piece to create the arc.



(5) Assemble front end parts of the TIG torch, fitting a sharpened tungsten suitable for DC welding.

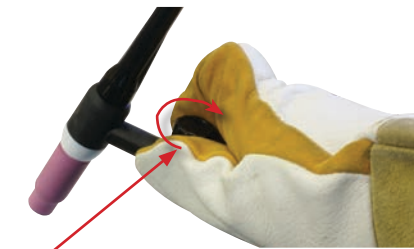

(6) Turn on the Gas Valve



(7) Lay the outside edge of the Gas Cup on the work piece with the Tungsten Electrode 1- 2mm from the work piece.

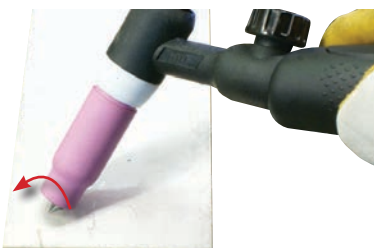

(8) With a small movement rotate the Gas Cup forward so that the Tungsten Electrode touches the work piece.

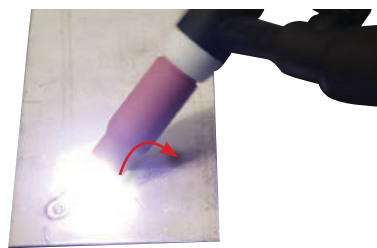

(9) Now rotate the Gas Cup in the reverse direction to lift the Tungsten electrode from the work piece to create the arc.

IMPORTANT! - We strongly recommend that you check for gas leakage prior to operation of your machine. We recommend that you close the cylinder valve when the machine is not in use.

Esseti NZ Ltd, authorised representatives or agents of Esseti NZ Ltd will not be liable or responsible for the loss of any gas.

DC TIG Welding

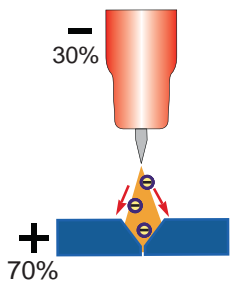

The DC power source uses what is known as DC (direct current) in which the main electrical component known as electrons flow in only one direction from the negative pole (terminal) to the positive pole (terminal). In the DC electrical circuit there is an electrical principle at work which should always be taken into account when using any DC circuit. With a DC circuit 70% of the energy (heat) is always on the positive side. This needs to be understood because it determines what terminal the TIG torch will be connected to (this rule applies to all the other forms of DC welding as well).

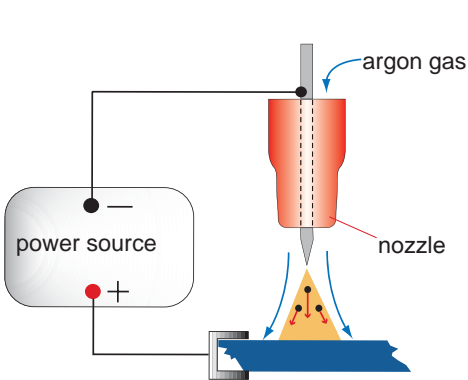

DC TIG welding is a process in which an arc is struck between a TUNGSTEN electrode and the metal work piece. The weld area is shielded by an inert gas flow to prevent contamination of the tungsten, molten pool and weld area.

When the TIG arc is struck the inert gas is ionized and superheated changing its molecular structure which converts it into a plasma stream. This plasma stream flowing between the tungsten and the work piece is the TIG arc and can be as hot as 19,000°C. It is a very pure and concentrated arc which provides the controlled melting of most metals into a weld pool. TIG welding offers the user the greatest amount of flexibility to weld the widest range of material and thickness and types. DC TIG welding is also the cleanest weld with no sparks or spatter.

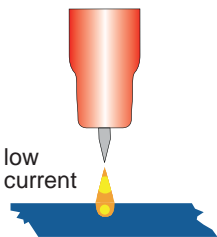

The intensity of the arc is proportional to the current that flows from the tungsten. The welder regulates the welding current to adjust the power of the arc. Typically thin material requires a less powerful arc with less heat to melt the material so less current (amps) is required, thicker material requires a more powerful arc with more heat so more current (amps) are necessary to melt the material.

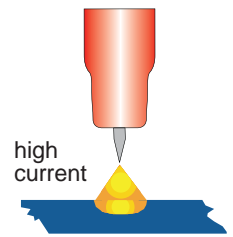

TIG WELDING GUIDE



TIG Welding Fusion Technique

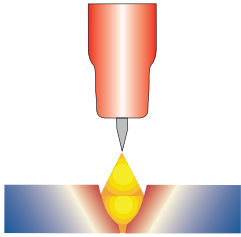

Manual TIG welding is often considered the most difficult of all the welding processes. Because the welder must maintain a short arc length, great care and skill are required to prevent contact between the electrode and the workpiece. Similar to Oxygen Acetylene torch welding, Tig welding normally requires two hands and in most instances requires the welder to manually feed a filler wire into the weld pool with one hand while manipulating the welding torch in the other. However, some welds combining thin materials can be accomplished without filler metal like edge, corner, and butt joints.

This is known as Fusion welding where the edges of the metal pieces are melted together using only the heat and arc force generated by the TIG arc. Once the arc is started the torch tungsten is held in place until a weld pool is created, a circular movement of the tungsten will assist in creating a weld pool of the desired size. Once the weld pool is established tilt the torch at about a 75° angle and move smoothly and evenly along the joint while fusing the materials together.

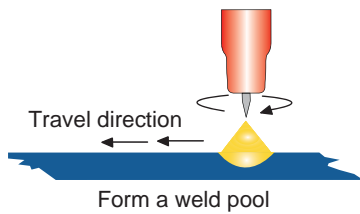

Form a weld pool

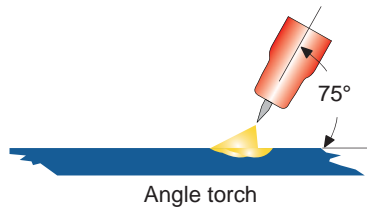

Angle torch

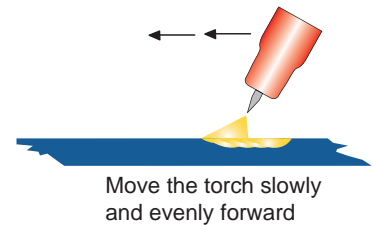

Move the torch slowly and evenly forward

TIG Welding with Filler Wire Technique

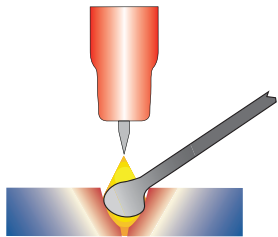

It is necessary in many situations with TIG welding to add a filler wire into the weld pool to build up weld reinforcement and create a strong weld. Once the arc is started the torch tungsten is held in place until a weld pool is created, a circular movement of the tungsten will assist in creating a weld pool of the desired size. Once the weld pool is established tilt the torch at about a 75° angle and move smoothly and evenly along the joint. The filler metal is introduced to the leading edge of the weld pool. The filler wire is usually held at about a 15° angle and fed into the leading edge of the molten pool, the arc will melt the filler wire into the weld pool as the torch is moved forward.

Also a dabbing technique can be used to control the amount of filler wire added, the wire is fed into the molten pool and retracted in a repeating sequence as the torch is moved slowly and evenly forward. It is important during the welding to keep the molten end of the filler wire inside the gas shield as this protects the end of the wire from being oxidised and contaminating the weld pool.

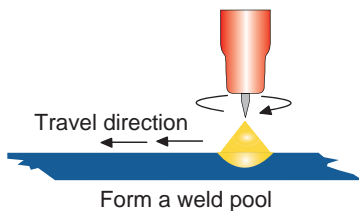

Form a weld pool

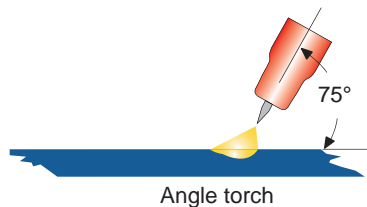

Angle torch

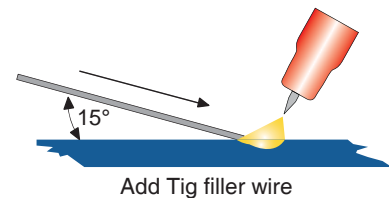

Add Tig filler wire

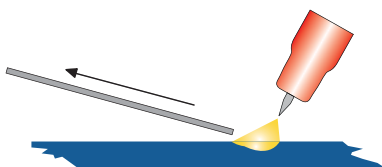

Retract the filler wire

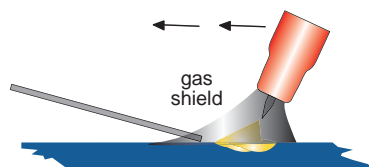

Move the torch forward to the front of the weld pool

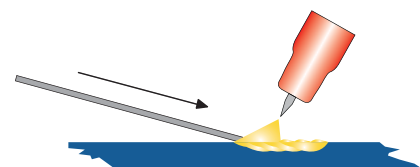

Repeat the process

Tungsten Electrodes

Tungsten is a rare metallic element used for manufacturing TIG welding electrodes. The TIG process relies on tungsten's hardness and high-temperature resistance to carry the welding current to the arc. Tungsten has the highest melting point of any metal, 3,410 degrees Celsius. Tungsten electrodes are nonconsumable and come in a variety of sizes, they are made from pure tungsten or an alloy of tungsten and other rare earth elements. Choosing the correct tungsten depends on the material being welded, amps required and whether you are using AC or DC welding current. Tungsten electrodes are colour-coded at the end for easy identification. Below are the most commonly used tungsten electrodes found in the New Zealand and Australian market.

Thoriated

Thoriated tungsten electrodes (AWS classification EWTh-2) contain a minimum of 97.30 percent tungsten and 1.70 to 2.20 percent thorium and are called 2 percent thoriated. They are the most commonly used electrodes today and are preferred for their longevity and ease of use. Thorium however is a low-level radioactive hazard and many users have switched to other alternatives. Regarding the radioactivity, thorium is an alpha emitter but when it is enclosed in a tungsten matrix the risks are negligible. Thoriated tungsten should not get in contact with open cuts or wounds. The more significant danger to welders can occur when thorium oxide gets into the lungs. This can happen from the exposure to vapours during welding or from ingestion of material/dust in the grinding of the tungsten. Follow the manufacturer's warnings, instructions, and the Material Safety Data Sheet (MSDS) for its use.

E3 (Color Code: Turquoise)

E3 tungsten electrodes (AWS classification EWG) contain a minimum of 98% percent tungsten and up to 1.5 percent Lanthanum and small percentages of Zirconium and Yttrium they are called E3 Tungsten. E3 Tungsten Electrodes provide conductivity similar to that of thoriated electrodes. Typically, this means that E3 Tungsten Electrodes are exchangeable with thoriated electrodes without requiring significant welding process changes. E3 deliver superior arc starting, electrode lifetime, and overall cost-effectiveness. When E3 Tungsten Electrodes are compared with 2% thoriated tungsten, E3 requires fewer re-grinds and provides a longer overall lifetime. Tests have shown that ignition delay with E3 Tungsten Electrodes actually improves over time, while 2% thoriated tungsten starts to deteriorate after only 25 starts. At equivalent energy output, E3 Tungsten Electrodes run cooler than 2% thoriated tungsten, thereby extending overall tip lifetime. E3 Tungsten Electrodes work well on AC or DC. They can be used DC electrode positive or negative with a pointed end, or balled for use with AC power sources.

Ceriated (Color Code: Grey)

Ceriated tungsten electrodes (AWS classification EWCe-2) contain a minimum of 97.30 percent tungsten and 1.80 to 2.20 percent cerium and are referred to as 2 percent ceriated. Ceriated tungstens perform best in DC welding at low current settings. They have excellent arc starts at low amperages and become popular in such applications as orbital tube welding, thin sheet metal work. They are best used to weld carbon steel, stainless steel, nickel alloys, and titanium, and in some cases it can replace 2 percent thoriated electrodes. Ceriated tungsten is best suited for lower amperages it should last longer than Thoriated tungsten higher amperage applications are best left to Thoriated or Lanthanated tungsten.

Lanthanated (Color Code: Gold)

Lanthanated tungsten electrodes (AWS classification EWLa-1.5) contain a minimum of 97.80 percent tungsten and 1.30 percent to 1.70 percent lanthanum, and are known as 1.5 percent lanthanated. These electrodes have excellent arc starting, a low burn off rate, good arc stability, and excellent re-ignition characteristics. Lanthanated tungstens also share the conductivity characteristics of 2 percent thoriated tungsten. Lanthanated tungsten electrodes are ideal if you want to optimise your welding capabilities. They work well on AC or DC electrode negative with a pointed end, or they can be balled for use with AC sine wave power sources. Lanthanated tungsten maintains a sharpened point well, which is an advantage for welding steel and stainless steel on DC or AC from square wave power sources.

Zirconiated (Color Code: White)

Zirconiated tungsten electrodes (AWS classification EWZr-1) contain a minimum of 99.10 percent tungsten and 0.15 to 0.40 percent zirconium. Most commonly used for AC welding Zirconiated tungsten produces a very stable arc and is resistant to tungsten spitting. It is ideal for AC welding because it retains a balled tip and has a high resistance to contamination. Its current-carrying capacity is equal to or greater than that of thoriated tungsten. Zirconiated tungsten is not recommended for DC welding.

Tungsten Electrodes Rating for Welding Currents

Tungsten Diameter mm	DC Current Amps Torch Negative 2% Thoriated	AC Current Amps Un-Balanced Wave 0.8% Zirconiated	AC Current Amps Balanced Wave 0.8% Zirconiated
1.0mm	15 - 80	15 - 80	20 - 60
1.6mm	70 - 150	70 - 150	60 - 120
2.4mm	150 - 250	140 - 235	100 - 180
3.2mm	250 - 400	225 - 325	160 - 250
4.0mm	400 - 500	300 - 400	200 - 320

Tungsten Preparation

Always use **DIAMOND** wheels when grinding and cutting. While tungsten is a very hard material, the surface of a diamond wheel is harder, and this makes for smooth grinding. Grinding without diamond wheels, such as aluminium oxide wheels, can lead to jagged edges, imperfections, or poor surface finishes not visible to the eye that will contribute to weld inconsistency and weld defects.

Always ensure to grind the tungsten in a longitudinal direction on the grinding wheel. Tungsten electrodes are manufactured with the molecular structure of the grain running lengthwise and thus grinding crosswise is “grinding against the grain.” If electrodes are ground crosswise, the electrons have to jump across the grinding marks and the arc can start before the tip and wander. Grinding longitudinally with the grain, the electrons flow steadily and easily to the end of the tungsten tip. The arc starts straight and remains narrow, concentrated, and stable.



Electrode Tip/Flat

The shape of the tungsten electrode tip is an important process variable in precision arc welding. A good selection of tip/flat size will balance the need for several advantages. The bigger the flat, the more likely arc wander will occur and the more difficult it will be to arc start. However, increasing the flat to the maximum level that still allows arc start and eliminates arc wander will improve the weld penetration and increase the electrode life. Some welders still grind electrodes to a sharp point, which makes arc starting easier. However, they risk decreased welding performance from melting at the tip and the possibility of the point falling off into the weld pool.



Electrode Included Angle/Taper - DC Welding

Tungsten electrodes for DC welding should be ground longitudinally and concentrically with diamond wheels to a specific included angle in conjunction with the tip/flat preparation. Different angles produce different arc shapes and offer different weld penetration capabilities. In general, blunter electrodes that have a larger included angle provide the following benefits:

- Last Longer
- Have better weld penetration
- Have a narrower arc shape
- Can handle more amperage without eroding.

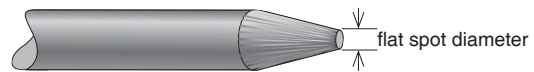

Sharper electrodes with smaller included angle provide:

- Offer less arc weld
- Have a wider arc
- Have a more consistent arc



The included angle determines weld bead shape and size. Generally, as the included angle increases, penetration increases and bead width decreases.

Tungsten Diameter	Diameter at the Tip - mm	Constant Included Angle - Degrees	Current Range Amps	Current Range Pulsed Amps
1.0mm	.250	20	05 - 30	05 - 60
1.6mm	.500	25	08 - 50	05 - 100
1.6mm	.800	30	10 - 70	10 - 140
2.4mm	.800	35	12 - 90	12 - 180
2.4mm	1.100	45	15 - 150	15 - 250
3.2mm	1.100	60	20 - 200	20 - 300
3.2mm	1.500	90	25 - 250	25 - 350

GAS FLOW REGULATORS

The job of the gas flow regulator is to reduce the bottle pressure gas down to a lower pressure and deliver it at a constant flow. This constant flow of gas is usually fed through the welding machine where it is controlled by a solenoid valve, operated when the torch trigger is pulled. Once the gas has passed the solenoid valve it flows down the torch cable exiting at the gas nozzle to protect the weld pool and surrounding area. There are two main types of flow regulators commonly used for MIG and TIG welding applications. Both regulator types perform the same function, but have a different way of setting and measuring the gas flow. A flow-gauge regulator (Fig.1) has a dial-type pressure gauge to measure the cylinder contents and a second gauge to measure and deliver the flow rate required. The flow-meter regulator (Fig.2) has a pressure gauge to measure the cylinder contents and a flow tube assembly to measure and deliver the flow rate required. Some flowmeter regulators will have two flow tube assemblies (Fig.3) typically one is used for supplying gas to the welding machine and the other is used for purging the welding area with gas prior to welding, during welding and post welding and at a separate rate of flow from that being supplied to the welding machine. The amount of gas flow needed to do the job will depend on the welding gas and the job being done, but a common setting to start with is 10 L/min.



Fig.1



Fig.2



Fig.3

SHIELDING GASES

Shielding gases are almost always necessary for MIG and TIG welding processes to protect the weld zone from gases that are contained in the surrounding atmosphere, particularly nitrogen and oxygen. If allowed into the weld zone these gases will contaminate the weld pool resulting in fusion defects also porosity and embrittlement of the weld metal. Selecting the right type of shielding gas depends on the welding process being used and type of material being welded. The MIG process is typically a mixture of Argon and Co₂ (AR90% Co₂ 10%) or pure Co₂ for steel welding applications, other specialised mixtures of Argon, Co₂, and Oxygen are available for stainless steel welding but with welding aluminium pure Argon is almost always used. The TIG welding process almost always requires 100% Argon for welding of all materials, however in some specialised applications Helium, or a Helium mix are sometimes used. Today with the multitude of gas mixes available through a number of different suppliers, it is difficult to list and recommend which gas mix is better for which job. If you are unsure about what gas or gas mix to use we recommend you discuss with your application local gas suppliers or your Esseti technical representative.

XA17V TIG TORCH & SPARES



XA17V TIG TORCH

Suregrip™ Series

150AMP AIR COOLED

Gas Valve Torch Head

Rating: 150A DC, 105AAC @35% duty cycle.

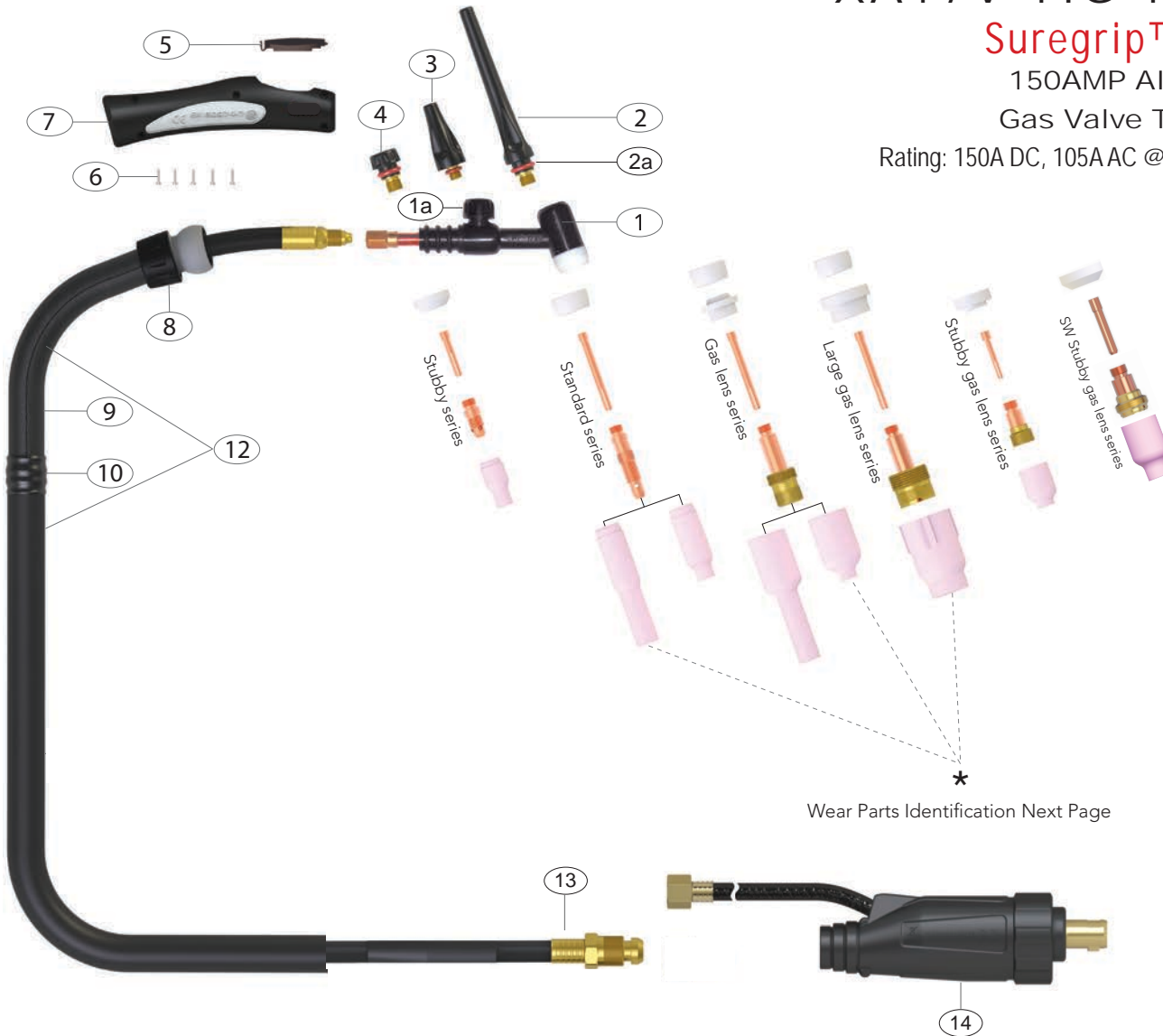

Wear Parts Identification Next Page

Torch Model Description	Part Number	
	4m	8m
XA17V Tig Torch 16-25 Twistlok End, 2m Gas Hose	XA17V-12NBD25	XA17V-25NBD25
XA17V Tig Torch 35-50 Twistlok End, 2m Gas Hose	XA17V-12NBD50	XA17V-25NBD50
XA17VFX Flexi Tig Torch 16-25 Twistlok End, 2m Gas Hose	XA17VFX-12NBD25	XA17VFX-25NBD25
XA17VFX Flexi Tig Torch 35-50 Twistlok End, 2m Gas Hose	XA17VFX-12NBD50	XA17VFX-25NBD50

Spare Parts		
Part Number	Description	
1	XA17V	Torch Body with Valve
	XA17VFX	Torch Body Flexible with Valve
1a	VS-2	Valve Stem
2	57Y02	Back Cap Long
2a	98W18	Back Cap O Ring
3	57Y05	Back Cap Medium
4	57Y04	Back Cap Short
5	ERBS	Blank Switch Cover (See page 174 for Switch options)
6	ERSP1	Screw Pack
7	ERH100	Small Ergo Tig Handle
8	ERKJ100	Small Knuckle Joint & Lock Nut
9	ERLC100-08	Leather Cover x 0.8m

Spare Parts		
Part Number	Description	
10	ERJK100	Jointing Repair Kit
12	ERCO100-40	Sheath x 4m c/w Leather Cover
	ERCO100-80	Sheath x 8m c/w Leather Cover
13	SLHD57Y01AOB	Power Cable x 4m Surelok OB Rubber
	SLHD57Y03AOB	Power Cable x 8m Surelok OB Rubber
15	UD1025-38	Dinse Tig Power Cable Connector 10-25
	UD3550-38	Dinse Tig Power Cable Connector 35-50
15	WGCP-1V-58	Gas Hose Assembly x 2m

XA17V TIG TORCH & SPARES





Standard Front End Parts

				
18CG Cup Gasket	10N22 Collet 1.0mm 10N23 Collet 1.6mm 10N24 Collet 2.4mm 10N25 Collet 3.2mm	10N30 Collet Body 1.0mm 10N31 Collet Body 1.6mm 10N32 Collet Body 2.4mm 10N28 Collet Body 3.2mm	10N50 Alumina Nozzle Ø 6mm #4 10N49 Alumina Nozzle Ø 8mm #5 10N48 Alumina Nozzle Ø 10mm #6 10N47 Alumina Nozzle Ø 11mm #7 10N46 Alumina Nozzle Ø 12.5mm #8 10N45 Alumina Nozzle Ø 16mm #10 10N44 Alumina Nozzle Ø 19mm #12	10N49L Long Alumina Nozzle Ø 8mm #5L 10N48L Long Alumina Nozzle Ø 10mm #6L 10N47L Long Alumina Nozzle Ø 11mm #7L



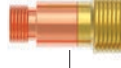

Stubby Front End Parts

				
18CG20 Stubby Cup Gasket	10N22S Stubby Collet 1.0mm 10N23S Stubby Collet 1.6mm 10N24S Stubby Collet 2.4mm 10N25S Stubby Collet 3.2mm	17CB20 Stubby Collet Body Fits 1.0 - 3.2mm	13N08 Alumina Nozzle Ø 6mm #4 13N09 Alumina Nozzle Ø 8mm #5 13N10 Alumina Nozzle Ø 10mm #6 13N11 Alumina Nozzle Ø 11mm #7 13N12 Alumina Nozzle Ø 13mm #8 13N13 Alumina Nozzle Ø 16mm #10	796F70 Long Alumina Nozzle Ø 5mm #3 796F71 Long Alumina Nozzle Ø 6mm #4 796F72 Long Alumina Nozzle Ø 8mm #5 796F73 Long Alumina Nozzle Ø 10mm #6



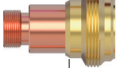

Ultra Stubby Gas Lens Front End Parts

			
USTB80300236 Gas Lens Gasket	10N22S Stubby Collet 1.0mm 10N23S Stubby Collet 1.6mm 10N24S Stubby Collet 2.4mm 10N25S Stubby Collet 3.2mm	USTB45V43 Stubby Gas Lens Body 1.6mm USTB45V44 Stubby Gas Lens Body 2.4mm USTB45V45 Stubby Gas Lens Body 3.2mm	53N58 Gas Lens Nozzle Ø 6mm #4 53N59 Gas Lens Nozzle Ø 8mm #5 53N60 Gas Lens Nozzle Ø 10mm #6 53N61 Gas Lens Nozzle Ø 11mm #7 53N61S Gas Lens Nozzle Ø 12.5mm #8

SW Stubby Gas Lens Front End Parts

			
18CG20 Stubby Cup Gasket	10N22S Stubby Collet 1.0mm 10N23S Stubby Collet 1.6mm 10N24S Stubby Collet 2.4mm 10N25S Stubby Collet 3.2mm	45V24S SW Stubby Gas Lens Body 1.0mm 45V25S SW Stubby Gas Lens Body 1.6mm 45V26S SW Stubby Gas Lens Body 2.4mm 45V27S SW Stubby Gas Lens Body 3.2mm	54N16SW Gas Lens Nozzle Ø 10mm #6 54N15SW Gas Lens Nozzle Ø 11mm #7 54N14SW Gas Lens Nozzle Ø 12.5mm #8 54N12SW Gas Lens Nozzle Ø 16.0mm #10

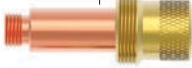
Gas Lens Front End Parts

				
18CG Cup Gasket 54N01 Gas Lens Gasket	10N22 Collet 1.0mm 10N23 Collet 1.6mm 10N24 Collet 2.4mm 10N25 Collet 3.2mm	45V24 Gas Lens Collet Body 1.0mm 45V25 Gas Lens Collet Body 1.6mm 45V26 Gas Lens Collet Body 2.4mm 45V27 Gas Lens Collet Body 3.2mm	54N18 Gas Lens Nozzle Ø 6mm #4 54N17 Gas Lens Nozzle Ø 8mm #5 54N16 Gas Lens Nozzle Ø 10mm #6 54N15 Gas Lens Nozzle Ø 11mm #7 54N14 Gas Lens Nozzle Ø 12.5mm #8 54N19 Gas Lens Nozzle Ø 17mm #11	54N18L Long Gas Lens Nozzle Ø 6mm #4L 54N17L Long Gas Lens Nozzle Ø 8mm #5L 54N16L Long Gas Lens Nozzle Ø 10mm #6L 54N15L Long Gas Lens Nozzle Ø 11mm #7L 54N14L Long Gas Lens Nozzle Ø 12.5mm #8L

Large Gas Lens Front End Parts

			
54N63 Large Lens Gasket	10N22 Collet 1.0mm 10N23 Collet 1.6mm 10N24 Collet 2.4mm 10N25 Collet 3.2mm	45V0204 Large Gas Lens Body 1.0mm 45V116 Large Gas Lens Body 1.6mm 45V64 Large Gas Lens Body 2.4mm 995795 Large Gas Lens Body 3.2mm	57N75 Large Gas Lens Nozzle Ø 10mm #6 57N74 Large Gas Lens Nozzle Ø 12.5mm #8 53N88 Large Gas Lens Nozzle Ø 16mm #10 53N87 Large Gas Lens Nozzle Ø 19mm #12

MMA (STICK) WELDING TROUBLE SHOOTING



The following chart addresses some of the common problems of MMA welding. In all cases of equipment malfunction, the manufacturer's recommendations should be strictly adhered to and followed.

1: No arc	
<i>Possible Reason</i>	<i>Suggested Remedy</i>
Incomplete welding circuit	Check earth lead is connected. Check all cable connections.
Wrong mode selected	Check the MMA selector switch is selected
No power supply	Check that the machine is switched on and has a power supply
2: Porosity – small cavities or holes resulting from gas pockets in weld metal.	
<i>Possible Reason</i>	<i>Suggested Remedy</i>
Arc length too long	Shorten the arc length
Work piece dirty, contaminated or moisture	Remove moisture and materials like paint, grease, oil, and dirt, including mill scale from base metal
Damp electrodes	Use only dry electrodes
3: Excessive Spatter	
<i>Possible Reason</i>	<i>Suggested Remedy</i>
Amperage too high	Decrease the amperage or choose a larger electrode
Arc length too long	Shorten the arc length
4: Weld sits on top, lack of fusion	
<i>Possible Reason</i>	<i>Suggested Remedy</i>
Insufficient heat input	Increase the amperage or choose a larger electrode
Work piece dirty, contaminated or moisture	Remove moisture and materials like paint, grease, oil, and dirt, including mill scale from base metal
Poor welding technique	Use the correct welding technique or seek assistance for the correct technique
5: Lack of penetration	
<i>Possible Reason</i>	<i>Suggested Remedy</i>
Insufficient heat input	Increase the amperage or choose a larger electrode
Poor welding technique	Use the correct welding technique or seek assistance for the correct technique
Poor joint preparation	Check the joint design and fit up, make sure the material is not too thick. Seek assistance for the correct joint design and fit up
6: Excessive penetration - burn through	
<i>Possible Reason</i>	<i>Suggested Remedy</i>
Excessive heat input	Reduce the amperage or use a smaller electrode
Incorrect travel speed	Try increasing the weld travel speed
7: Uneven weld appearance	
<i>Possible Reason</i>	<i>Suggested Remedy</i>
Unsteady hand, wavering hand	Use two hands where possible to steady up, practise your technique
8: Distortion – movement of base metal during welding	
<i>Possible Reason</i>	<i>Suggested Remedy</i>
Excessive heat input	Reduce the amperage or use a smaller electrode
Poor welding technique	Use the correct welding technique or seek assistance for the correct technique
Poor joint preparation and or joint design	Check the joint design and fit up, make sure the material is not too thick. Seek assistance for the correct joint design and fit up
9: Electrode welds with different or unusual arc characteristic	
<i>Possible Reason</i>	<i>Suggested Remedy</i>
Incorrect polarity	Change the polarity, check the electrode manufacturer for correct polarity

The following chart addresses some of the common problems of TIG welding. In all cases of equipment malfunction, the manufacturer's recommendations should be strictly adhered to and followed.

1: Tungsten burning away quickly	
<i>Possible Reason</i>	<i>Suggested Remedy</i>
Incorrect Gas or No Gas	Use pure Argon. Check cylinder has gas, connected, turned on and torch valve is open
Inadequate gas flow	Check the gas is connected, check hoses, gas valve and torch are not restricted.
Back cap not fitted correctly	Make sure the torch back cap is fitted so that the o-ring is inside the torch body
Torch connected to DC +	Connect the torch to the DC- output terminal
Incorrect tungsten being used	Check and change the tungsten type if necessary
Tungsten being oxidised after weld is finished	Keep shielding gas flowing 10–15 seconds after arc stoppage. 1 second for each 10 amps of weld current.
2: Contaminated tungsten	
<i>Possible Reason</i>	<i>Suggested Remedy</i>
Touching tungsten into the weld pool	Keep tungsten from contacting weld puddle. Raise the torch so that the tungsten is off of the work piece 2 - 5mm
Touching the filler wire to the tungsten	Keep the filler wire from touching the tungsten during welding, feed the filler wire into the leading edge of the weld pool in front of the tungsten
3: Porosity - poor weld appearance and colour	
<i>Possible Reason</i>	<i>Suggested Remedy</i>
Wrong gas / poor gas flow /gas leaks	Use pure argon.Gas is connected, check hoses, gas valve and torch are not restricted. Set the gas flow between 6-12 l/min. Check hoses and fittings for holes, leaks etc.,
Contaminated base metal	Remove moisture and materials like paint, grease, oil, and dirt from base metal
Contaminated filler wire	Remove all grease, oil, or moisture from filler metal.
Incorrect filler wire	Check the filler wire and change if necessary
4: Yellowish residue / smoke on the alumina nozzle & discoloured tungsten	
<i>Possible Reason</i>	<i>Suggested Remedy</i>
Incorrect Gas	Use pure Argon gas
Inadequate gas flow	Set the gas flow between 10 - 15 l/min flow rate
Alumina gas nozzle too small	Increase the size of the alumina gas nozzle
5: Unstable Arc during DC welding	
<i>Possible Reason</i>	<i>Suggested Remedy</i>
Torch connected to DC +	Connect the torch to the DC- output terminal
Contaminated base metal	Remove materials like paint, grease, oil, and dirt, including mill scale from base metal.
Tungsten is contaminated	Remove 10mm of contaminated tungsten and re grind the tungsten
Arc length too long	Lower torch so that the tungsten is off of the work piece 2 - 5mm
7: Arc wanders during DC welding	
<i>Possible Reason</i>	<i>Suggested Remedy</i>
Poor gas flow	Check and set the gas flow between 10 - 15 l/min flow rate
Incorrect arc length	Lower torch so that the tungsten is off of the work piece 2 - 5mm
Tungsten incorrect or in poor condition	Check that correct type of tungsten is being used. Remove 10mm from the weld end of the tungsten and re sharpen the tungsten
Poorly prepared tungsten	Grind marks should run lengthwise with tungsten, not circular. Use proper grinding method and wheel.
Contaminated base metal or filler wire	Remove contaminating materials like paint, grease, oil, and dirt, including mill scale from base metal. Remove all grease, oil, or moisture from filler metal.
8: Arc difficult to start or will not start DC welding	
<i>Possible Reason</i>	<i>Suggested Remedy</i>
Incorrect machine set up	Check machine set up is correct
No gas, incorrect gas flow	Check the gas is connected and cylinder valve open, check hoses, gas valve and torch are not restricted. Set the gas flow between 10 - 15 l/min flow rate
Incorrect tungsten size or type	Check and change the size and or the tungsten if required
Loose connection	Check all connectors and tighten
Earth clamp not connected to work	Connect the earth clamp directly to the work piece wherever possible

WARRANTY TERMS



ESSETI New Zealand Limited ('us', 'we') warrants that the products bearing the brand names ESSETI, XCEL-ARC, RAZORWELD, RAZORCUT, JASIC, VIPER, T&R, XCEL-GAS, Otos, Servore, TECNA & HIT-8SS supplied by us and purchased by you from an Authorised ESSETI (NZ) Ltd. Distributor are free of Material and Faulty Workmanship Defects except for those products listed under 'Warranty Exclusions' and whilst any claim is made subject to the following terms and conditions.

Your rights under the New Zealand Consumer Law may not be limited by a defined time. However, New Zealand Consumer Law does recognise that the relevant time period can vary from product to product, depending on factors such as the nature of the product and the price. Esseti NZ Ltd. adopts the same approach. As you can appreciate, the type of remedy we can offer you may also vary depending on how long it takes you to return the product to us.

WARRANTY PERIOD

We offer the following 'Warranty Periods' from 'date of purchase':

An Extended Warranty Period of 6 months total shall apply only to Machinery where offered and warranty is registered online.

We offer the following 'Warranty Periods' effective from the 'date of purchase':

XCEL-ARC, Inverter MIG/SWF/MTS, MMA/TIG, TIG ACDC, Plasma (Power Source Only*)	2 Years
RAZORWELD, Inverter MIG/SWF/MTS, MMA/TIG, TIG ACDC (Power Source Only*)	3 Years
RAZORCUT, Inverter Plasma (Power Source Only*)	3 Years
VIPER MIG185, Viper TIG180ACDC (Power Source Only*)	2 Years
VIPER ARC140, VIPER ARC160, VIPER CUT30, (Power Source Only*)	1 Year
VIPER TIG200P, VIPER SYNERGIC MIG 120 (Power Source Only*)	1 Year
JASIC, Inverter MIG/SWF/MTS, MMA/TIG, TIG ACDC, Plasma (Power Source Only*)	2 Years
XCEL-ARC & RAZORWELD, Water Coolers, PAPR Air Blower Unit	1 Year
XCEL-GAS, Gas Cutting and Welding Torches	3 Months
XCEL-GAS, Straight Line & Gas Cutting Machines (Machine Only*)	1 Year
XCEL-GAS, Regulators Argon/ Acetylene / Oxygen / LPG / Bobbin Flowmeter	1 Year
XCEL-ARC, Automatic Welding Helmet	2 Years
RAZORSHIELD Digital Welding Mask & Goggle Kit , Automatic Welding Helmets	2 Year
TECNA, Spot Welding Machines (Power Source Only*)	1 Year
ALL WELDING TORCHES – GMAW / GTAW / MMAW / PLASMA	3 Months
ALL EARTH LEADS, INTERCONNECTING CABLES, GAS HOSES	3 Months

(*) This only covers manufacturing faults on any torches, cables and other accessories, either included with a machine kitset or sold separately, for the first three months after date of purchase.



**REGISTER YOUR MACHINE ONLINE TO RECEIVE AN
ADDITIONAL 6 MONTHS ON YOUR WARRANTY**

Visit XcelArc.nz/warranty-registration/ to register your machine.

WARRANTY / RETURNS / EXCHANGES

Our Warranty Returns Policy recognises all and any rights you have under New Zealand Consumer Law and other relevant laws.

You shall inspect the goods on delivery and shall within seven (7) days of delivery (time being of the essence) notify the Esseti NZ Ltd. Authorised Distributor from whom you purchased the goods of any alleged defect, shortage in quantity, damage or failure to comply with the description or quote.

You shall also afford Esseti NZ Ltd. the opportunity to inspect the goods within a reasonable time following delivery if you believe the goods are defective in any way.

If you shall fail to comply with these provisions the goods shall be presumed to be free from any defect or damage. For defective goods and where permissible by law, Esseti NZ Ltd. reserves the right to repair or otherwise remedy the defect prior to issuing replacement goods or refunding the purchase price.

If the goods are being purchased for a business purpose then the purchaser acknowledges that the Consumer Guarantees Act will not apply.

The New Zealand Sales of Goods Act applies when goods are not covered by the Consumer Guarantees Act. You may be able to get a full refund or compensation if the trader doesn't have the right to sell the goods, or the goods are:

- not of 'merchantable quality' (so defective that most people wouldn't want them)
- not fit for their normal purpose
- poorer quality than a sample you were shown
- not suitable for what you told the trader you wanted the goods for
- not matching their description

If there has been a misrepresentation you may have rights under the Fair Trading Act or the Contractual Remedies Act and therefore also entitled to, at the consumer's discretion, either a refund of the purchase price of the goods, or repair of the goods, or replacement of the goods.

Returns will only be accepted provided that:

- (a) You have complied with the provisions outlined above, and
- (b) where the goods are unable to be repaired, the goods are returned at your cost within thirty (30) days of the delivery date, and
- (c) Esseti NZ Ltd. will not be liable for goods which have not been stored or used in a proper manner, and
- (d) the goods are returned in the condition in which they were delivered and with all packaging material, brochures and instructional material in as new condition as is reasonably possible in the circumstances.

Esseti NZ Ltd Accepts no responsibility for any products lost, damaged or mislaid whilst in transit. Esseti NZ Ltd. may (at their sole discretion) accept the return of goods for credit but this may incur a handling fee of up to fifteen percent (15%) of the value of the returned Goods plus any freight costs.

MAKING A CLAIM

If you wish to make a claim under this Warranty, you should:

- Return the product to the point of purchase either in person or via prepaid courier; or
- Contact us by Telephone – Esseti NZ Ltd – 06 355 1103

When returned, the product must be accompanied with the original Receipt or Tax Invoice clearly showing the purchase date and disclosing the purchase price. All costs of installation, cartage, freight, travelling expenses, hiring tools and insurance are paid by the Customer. To the extent permitted by law, our total liability for loss or damage of every kind related to the goods in any way whatsoever is limited to the amount paid to the retailer by you for the goods or the value of the goods. No responsibility will be taken for any products lost, damaged or mislaid whilst in transit.

WARRANTY EXCLUSIONS

This Warranty covers Material and Faulty Workmanship defects only.

This Warranty does not cover damage caused by:

- Normal wear and tear due to usage
- Misuse or abusive use of the machine and/or failure to correctly follow set up or operating instructions supplied with these products
- Failure to clean or improper cleaning of the product
- Failure to maintain the equipment such as regular services, etc.
- Incorrect voltage or non-authorized electrical connections
- Improper installation
- Use of non-authorized/non-standard parts
- Abnormal product performance caused by any ancillary equipment interference or other external factors
- Failure or any breakage caused by overload, dropping or abusive treatment or use by the customer
- Repair, modifications or other work carried out on the product other than by an Esseti-Authorised Service Agent

Unless it is a manufacturing fault, this Warranty does not cover the following parts:

• **All Batteries, including Button Type and Cell Type Batteries**

• **MIG Welding Torch Consumables, such as:**

Gas Nozzles, Gas Diffusers, Contact Tip Holders, Contact Tips, Swan Necks, Triggers, Handles, Liners, Euro Block, Shroud Springs, Knobs, All XCEL-ARC / Magmaweld Mig Welding Wires & Electrodes, Arc Leads, Welding Cable, Electrode Holder, Earth Clamps

• **MMA & TIG Welding Torch Consumables, such as:**

Tungsten Electrodes, Collet, Collet Body, Alumina Nozzle, Torch Head, Torch Head water Cooled, Torch Head Flexible, Back Caps, Gas Lens, Torch Handle, Cup Gasket, Torch Body Gas Valve, O-ring, All XCEL-ARC TIG Welding Rods, All XCEL-ARC / Magmaweld Electrodes, Arc Leads, Welding Cable, Electrode Holder, Earth Clamps

• **PLASMA Cutting Torches Consumables, such as:**

All Cutting Tips, All Diffuser/Swirl Ring, All Electrodes, Retaining Caps, Nozzle Springs, All Spacers, All Shield Caps, All Air and Power Cables, All Switches, All O-rings, All Springs, All Circle Guides and Cutting Kits, Torch Bodies, Air Filter Regulator, Welding Cable, Earth Clamps

• **Gas Welding & Cutting Torch and Straight Line Cutting Machine Consumables and Fittings, such as:**

All Cutting, Welding & Brazing Tips, Adaptors, Hoses, Fittings, Tracks and associated parts

• **Automatic Welding & Cutting Carriage Machine Parts, such as:**

Input Cord, Inter-connecting Power Cord, Triggering Cable

This Warranty does not cover products purchased:

- Without the provision of a suitable Receipt or Tax Invoice that clearly provides proof of purchase as outlined above
- At an auction or from a private seller
- Unless it is a manufacturing fault, this Warranty does not apply to any products sold to Hire Companies.

These conditions may only be varied with the written approval of the Directors of Esseti NZ Limited.

REMEMBER TO RETAIN YOUR ORIGINAL INVOICE FOR PROOF OF PURCHASE.

A series of horizontal dotted lines for taking notes.



Esseti New Zealand Limited
PO Box 4189, Palmerston North - 4442
Phone: 06 355 1103
Fax: (06) 354 2437
Email: sales@esseti.co.nz
www.esseti.co.nz