



# ARC140V - ARC160V

## DC INVERTER WELDERS

### OPERATORS MANUAL



**WELDING TECHNOLOGY**  
SUPPLIERS OF WELDING AND ENGINEERING EQUIPMENT

Please read and understand this instruction manual carefully before the installation and operation of this equipment.

Ph: 09 474 1240  
info@weldingtechnology.co.nz  
www.weldingtechnology.co.nz

## CONTENTS

## PAGE

Warranty	2
Safety	3-4
Caution, Maintenance and Trouble Shooting	5
Technical Data, Product Information	6-7
Machine Layout Descriptions	8
Installation & Operation for MMA (stick) Welding	9
MMA (Stick) Welding	10-11
Installation & Operation for DC TIG Welding with Lift Arc	12-13
DC TIG Welding - Lift Arc Technique	14
TIG Welding Fusion and Filler Wire Technique	15
Tungsten Electrodes - Tungsten Preparation	16-17
TIG Torch Parts Breakdown	18-19
Trouble Shooting Guide - MMA (Stick) Welding	20
Trouble Shooting Guide - TIG Welding	21-22
Machine Spare Parts Identification	23

### **Thank you for your purchase of your Xcel-Arc welding machine.**

We are proud of our range of welding equipment that has a proven track record of innovation, performance and reliability.

Our product range represents the latest developments in Inverter technology put together by our professional team of highly skilled engineers. The expertise gained from our long involvement with inverter technology has proven to be invaluable towards the evolution and future development of our equipment range. This experience gives us the inside knowledge on what the arc characteristics, performance and interface between man and machine should be.

Within our team are specialist welders that have a proven history of welding knowledge and expertise, giving vital input towards ensuring that our machines deliver control and performance to the utmost professional level.

We employ an expert team of professional sales, marketing and technical personnel that provide us with market trends, market feedback and customer comments and requirements. Secondly they provide a customer support service that is second to none, thus ensuring our customers have confidence that they will be well satisfied both now and in the future.

Xcel-Arc welders are manufactured and compliant with - AS/NZ60974.1 2006 - AS60974-6:2006 guaranteeing you electrical safety and performance.

## WARRANTY

- 1 Year from date of purchase.
- Esseti NZ Ltd warranties all goods as specified by the manufacturer of those goods.
- This Warranty does not cover freight or goods that have been interfered with.
- All goods in question must be repaired by an authorised repair agent as appointed by this company.
- Warranty does not cover abuse, mis-use, accident, theft, general wear and tear.
- New product will not be supplied unless Esseti NZ Ltd has inspected product returned for warranty and agree's to replace product. Ph: **09 274 1246**
- Product will only be replaced if repair is not possible.

# SAFETY

Welding and cutting equipment can be dangerous to both the operator and people in or near the surrounding working area, if the equipment is not correctly operated. Equipment must only be used under the strict and comprehensive observance of all relevant safety regulations. Read and understand this instruction manual carefully before the installation and operation of this equipment.

## Machine Operating Safety

- Do not switch the function modes while the machine is operating. Switching of the function modes during welding can damage the machine. Damage caused in this manner will not be covered under warranty.
- Disconnect the electrode-holder cable from the machine before switching on the machine, to avoid arcing should the electrode be in contact with the work piece.
- Operators should be trained and or qualified.



**Electric shock: It can kill.** Touching live electrical parts can cause fatal shocks or severe burns. The electrode and work circuit is electrically live whenever the output is on. The input power circuit and internal machine circuits are also live when power is on. In Mig/Mag welding, the wire, drive rollers, wire feed housing, and all metal parts touching the welding wire are electrically live. Incorrectly installed or improperly grounded equipment is dangerous.

- Connect the primary input cable according to Australian and New Zealand standards and regulations.
- Avoid all contact with live electrical parts of the welding circuit, electrodes and wires with bare hands. The operator must wear dry welding gloves while he/she performs the welding task.
- The operator should keep the work piece insulated from himself/herself.
- Keep cords dry, free of oil and grease, and protected from hot metal and sparks.
- Frequently inspect input power cable for wear and tear, replace the cable immediately if damaged, bare wiring is dangerous and can kill.
- Do not use damaged, under sized, or badly joined cables.
- Do not drape cables over your body.



**Fumes and gases are dangerous.** Smoke and gas generated whilst welding or cutting can be harmful to people's health. Welding produces fumes and gases. Breathing these fumes and gases can be hazardous to your health.

- Do not breathe the smoke and gas generated whilst welding or cutting, keep your head out of the fumes
- Keep the working area well ventilated, use fume extraction or ventilation to remove welding fumes and gases.
- In confined or heavy fume environments always wear an approved air-supplied respirator. Welding fumes and gases can displace air and lower the oxygen level causing injury or death. Be sure the breathing air is safe.
- Do not weld in locations near de-greasing, cleaning, or spraying operations. The heat and rays of the arc can react with vapours to form highly toxic and irritating gases.
- Materials such as galvanized, lead, or cadmium plated steel, containing elements that can give off toxic fumes when welded. Do not weld these materials unless the area is very well ventilated, and or wearing an air supplied respirator.



**Arc rays: harmful to people's eyes and skin.** Arc rays from the welding process produce intense visible and invisible ultraviolet and infrared rays that can burn eyes and skin.

- Always wear a welding helmet with correct shade of filter lens and suitable protective clothing including welding gloves whilst the welding operation is performed.
- Measures should be taken to protect people in or near the surrounding working area. Use protective screens or barriers to protect others from flash, glare and sparks; warn others not to watch the arc.

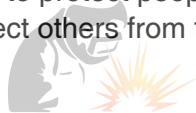



**Fire hazard.** Welding on closed containers, such as tanks, drums, or pipes, can cause them to explode. Flying sparks from the welding arc, hot work piece, and hot equipment can cause fires and burns. Accidental contact of electrode to metal objects can cause sparks, explosion, overheating, or fire. Check and be sure the area is safe before doing any welding.

- The welding sparks may cause fire, therefore remove any flammable materials away from the working area, at least 12m from the welding arc. Cover flammable materials and containers with approved covers if unable to be moved from the welding area.
- Do not weld on closed containers such as tanks, drums, or pipes, unless they are properly prepared according to the required Safety Standards to insure that flammable or toxic vapors and substances are totally removed, these can cause an explosion even though the vessel has been “cleaned”. Vent hollow castings or containers before heating, cutting or welding. They may explode.
- Do not weld where the atmosphere may contain flammable dust, gas, or liquid vapours (such as petrol)
- Have a fire extinguisher nearby and know how to use it. Be alert that welding sparks and hot materials from welding can easily go through small cracks and openings to adjacent areas. Be aware that welding on a ceiling, floor, bulkhead, or partition can cause fire on the hidden side.

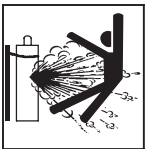

**Gas Cylinders.** Shielding gas cylinders contain gas under high pressure. If damaged, a cylinder can explode. Because gas cylinders are normally part of the welding process, be sure to treat them carefully. CYLINDERS can explode if damaged.

- Protect gas cylinders from excessive heat, mechanical shocks, physical damage, slag, open flames, sparks, and arcs.
- Insure cylinders are held secure and upright to prevent tipping or falling over.
- Never allow the welding electrode or earth clamp to touch the gas cylinder, do not drape welding cables over the cylinder.
- Never weld on a pressurised gas cylinder, it will explode and kill you.
- Open the cylinder valve slowly and turn your face away from the cylinder outlet valve and gas regulator.



**Gas build up.** The build up of gas can causes a toxic environment, deplete the oxygen content in the air resulting in death or injury. Many gases use in welding are invisible and odourless.

- Shut off shielding gas supply when not in use.
- Always ventilate confined spaces or use approved air-supplied respirator.



**Electronic magnetic fields.** MAGNETIC FIELDS can affect Implanted Medical Devices.

- Wearers of Pacemakers and other Implanted Medical Devices should keep away.
- Implanted Medical Device wearers should consult their doctor and the device manufacturer before going near any electric welding, cutting or heating operation.



**Noise can damage hearing.** Noise from some processes or equipment can damage hearing. Wear approved ear protection if noise level is high.



**Hot parts.** Items being welded generate and hold high heat and can cause severe burns. Do not touch hot parts with bare hands. Allow a cooling period before working on the welding gun. Use insulated welding gloves and clothing to handle hot parts and prevent burns.

WELDING TECHNOLOGY  
SUPPLIERS OF WELDING AND ENGINEERING EQUIPMENT



Ph: 09 274 1246  
info@weldingtechnology.co.nz  
www.weldingtechnology.co.nz

# CAUTION

## 1. Working Environment.

- 1.1 The environment in which this welding equipment is installed must be free of grinding dust, corrosive chemicals, flammable gas or materials etc, and at no more than maximum of 80% humidity.
- 1.2 When using the machine outdoors protect the machine from direct sun light, rain water and snow etc; the temperature of working environment should be maintained within -10°C to +40°C.
- 1.3 Keep this equipment 30cm distant from the wall.
- 1.4 Ensure the working environment is well ventilated.

## 2. Safety Tips.

### 2.1 Ventilation

This equipment is small-sized, compact in structure, and of excellent performance in amperage output. The fan is used to dissipate heat generated by this equipment during the welding operation.

**Important:** Maintain good ventilation of the louvers of this equipment. The minimum distance between this equipment and any other objects in or near the working area should be 30 cm. Good ventilation is of critical importance for the normal performance and service life of this equipment.

### 2.2 Thermal Overload protection.

Should the machine be used to an excessive level, or in high temperature environment, poorly ventilated area or if the fan malfunctions the Thermal Overload Switch will be activated and the machine will cease to operate. Under this circumstance, leave the machine switched on to keep the built-in fan working to bring down the temperature inside the equipment. The machine will be ready for use again when the internal temperature reaches safe level.

### 2.3 Over-Voltage Supply

Regarding the power supply voltage range of the machine, please refer to “Main parameter” table. This equipment is of automatic voltage compensation, which enables the maintaining of the voltage range within the given range. In case that the voltage of input power supply amperage exceeds the stipulated value, it is possible to cause damage to the components of this equipment. Please ensure your primary power supply is correct.

- 2.4 Do not come into contact with the output terminals while the machine is in operation. An electric shock may possibly occur.

## MAINTENANCE

Exposure to extremely dusty, damp, or corrosive air is damaging to the welding machine. In order to prevent any possible failure or fault of this welding equipment, clean the dust at regular intervals with clean and dry compressed air of required pressure.

**Please note that:** lack of maintenance can result in the cancellation of the guarantee; the guarantee of this welding equipment will be void if the machine has been modified, attempt to take apart the machine or open the factory-made sealing of the machine without the consent of an authorized representative of the manufacturer.

## TROUBLE SHOOTING

Caution: Only qualified technicians are authorized to undertake the repair of this welding equipment. For your safety and to avoid Electrical Shock, please observe all safety notes and precautions detailed in this manual.

**WELDING TECHNOLOGY**  
SUPPLIERS OF WELDING AND ENGINEERING EQUIPMENT



Ph: 09 274 1246  
info@weldingtechnology.co.nz  
www.weldingtechnology.co.nz

# VIPER ARC140

## MMA/TIG - 140 Amp DC Inverter Welder

Welds: Steels, Stainless, Cast Iron, Bronze, Copper



## VIPER ARC140

Approved Domestic Power Supply 10 Amp

230V Single Phase 140 Amp DC Welder

Small, Lightweight and Portable

### Features

- Latest IGBT inverter technology
- MMA (stick electrode)
  - Hot start (improves electrode starting)
  - Arc Force (boosts current to prevent electrode extinguishing)
  - Excellent arc stability with all electrodes
- DC Scratch TIG
  - Scratch Arc Ignition, basic DC TIG application
- Thermal overload protection
- IP21S rating for environmental/safety protection
- Generator compatible (recommend 6.5 KVA minimum)
- Tolerant to variable power supplies
- Fitted with and approved to use domestic 10 amp plug

**12 MONTH**  
Machine Warranty



### Technical Data

Power Supply / Phases (V-Ph)	240V - 1 ±15%
Rated Input Power (KVA)	6.49
ieff (Amps)	10.0A
Rated Input Current (A)	27.4
Rated Output	140A/25.6V
Welding Current Range	20~140A
No-Load Voltage (V)	66
Duty Cycle @ 40°C as per AS/NZ60974	15%@140Amps MMA
Efficiency (%)	85
Power Factor	0.65
Protection Class	IP21S
Insulation Class	F
Size (mm) with handle (LxWxH)	295 x 135 x 270
Weight (kg)	3.8
Warranty	12 months machine only
Certification Approval	AS/NZ60974-1



XA-AL140  
Standard Package

XATK1  
Optional TIG Kit 4m

### Overview

The VIPER140 is a new generation, low cost welding machine produced using the latest in IGBT inverter technology. Designed to meet the needs of the price conscious non-commercial user without compromising on quality, this machine is as reliable and robust as you would expect a machine bearing the Xcel-Arc name to be. The DC MMA welding function delivers a smooth and incredibly stable arc allowing easy welding with electrodes producing high quality welds including cast Iron, stainless steel and low hydrogen. The VIPER140 is also equipped with DC Scratch Start TIG capability and connection of the XA17V Tig torch allows DC Tig welding of steel, stainless steel, bronze and copper. The VIPER 140 is an exceptional machine for the price and is suitable for a wide range of applications including light fabrication, farming and whatever else a Kiwi bloke might be working on in his shed. The VIPER140 offers great portability with the power to get the job done and with the convenience of being fitted with a 10 amp domestic plug. Manufactured in compliance to AS/NZ60974.1.

### Product Code: XA-ARC140V

Standard package includes: VIPER ARC140 Machine, Earth Lead & Arc Lead 16mm x 2.5m

WELDING TECHNOLOGY  
SUPPLIERS OF WELDING AND ENGINEERING EQUIPMENT



Ph: 09 274 1246  
info@weldingtechnology.co.nz  
www.weldingtechnology.co.nz

# VIPER ARC160

## MMA/TIG - 160 Amp DC Inverter Welder

Welds: Steels, Stainless, Cast Iron, Bronze, Copper



## VIPER ARC160

Light Industrial DC Arc Welder  
230V Single Phase 160 Amp DC Welder  
Small, Lightweight and Portable

### Features

- Latest IGBT inverter technology
- MMA (stick electrode)
  - Hot start (improves electrode starting)
  - Arc Force (boosts current to prevent electrode extinguishing)
  - Excellent arc stability with all electrodes
- DC Scratch TIG
  - Scratch Arc Ignition, basic DC TIG application
- Thermal overload protection
- IP21S rating for environmental/safety protection
- Generator compatible (recommend 8.0 KVA minimum)
- Tolerant to variable power supplies

**12 MONTH**  
Machine Warranty



### Technical Data

Power Supply / Phases (V-Ph)	240V - 1 ±15%
Rated Input Power (KVA)	8.0
ieff (Amps)	12.8A
Rated Input Current (A)	27.4
Rated Output	160A/26.4V
Welding Current Range	20~160A
No-Load Voltage (V)	62.9
Duty Cycle @ 40°C as per AS/NZ60974	20%@160Amps MMA
Efficiency (%)	85
Power Factor	0.63
Protection Class	IP21S
Insulation Class	F
Size (mm) with handle (LxWxH)	295 x 135 x 270
Weight (kg)	4.9
Warranty	12 months machine only
Certification Approval	AS/NZ60974-1



XA-AL160  
Standard Package

XATK1  
Optional TIG Kit 4m

### Overview

The VIPER160 is a new generation, low cost welding machine produced using the latest in IGBT inverter technology. Designed to meet the needs of the price conscious non-commercial user without compromising on quality, this machine is as reliable and robust as you would expect a machine bearing the Xcel-Arc name to be. The DC MMA welding function delivers a smooth and incredibly stable arc allowing easy welding with electrodes producing high quality welds including cast iron, stainless steel and low hydrogen. The VIPER160 is also equipped with DC Scratch Start TIG capability and connection of the XA17V TIG torch allows DC TIG welding of steel, stainless steel, bronze and copper. The VIPER160 is an exceptional machine for the price and is suitable for a wide range of applications including light fabrication, farming and whatever else a Kiwi bloke might be working on in his shed. The VIPER160 offers great portability with the power to get the job done and with the convenience 230V single phase connection. Manufactured in compliance to AS/NZ60974.1.

### Product Code: XA-ARC160V

Standard package includes: VIPER ARC160 Machine, Earth Lead & Arc Lead 16mm x 2.5m

**WELDING TECHNOLOGY**  
SUPPLIERS OF WELDING AND ENGINEERING EQUIPMENT



Ph: 09 274 1246  
info@weldingtechnology.co.nz  
www.weldingtechnology.co.nz

## Front Machine Layout Description



## Rear Machine Layout Description





# Installation set up for MMA (Stick) Welding with ARCLITE 140/160

- (1) **Connection of Output Cables:** Various electrodes require a different polarity for optimum results refer to the electrode manufacturers information for the correct polarity. Most GP electrodes are Electrode connected to  $\ominus$  output socket, Earth Connected to the  $\oplus$  output socket
- (2) Connect the machine to the power supply and switch on using the on/off switch on the back panel.
- (3) Set the welding current relevant to the electrode type and size being used as recommended by the electrode manufacturer.
- (4) Place the electrode into the electrode holder and clamp tight
- (5) Strike the electrode on the work to create the arc and hold the electrode steady to maintain the arc
- (6) Hold the electrode slightly above the work piece to maintain the arc while travelling at an even speed to create and even weld deposition
- (7) To finish the weld, break the arc by quickly snapping the electrode away from the work piece.
- (8) Wait for the weld to cool and carefully chip away the slag to reveal the weld metal underneath



1246  
@weldingtechnology.co.nz

www.weldingtechnology.co.nz

# MMA (Manual Metal Arc) Welding

One of the most common types of arc welding is manual metal arc welding (MMA) or stick welding. An electric current is used to strike an arc between the base material and a consumable electrode rod or 'stick'. The electrode rod is made of a material that is compatible with the base material being welded and is covered with a flux that gives off gaseous vapours that serve as a shielding gas and providing a layer of slag, both of which protect the weld area from atmospheric contamination. The electrode core itself acts as filler material the residue from the flux that forms a slag covering over the weld metal must be chipped away after welding.

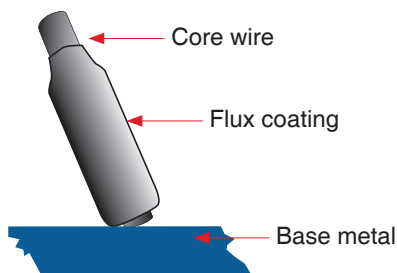
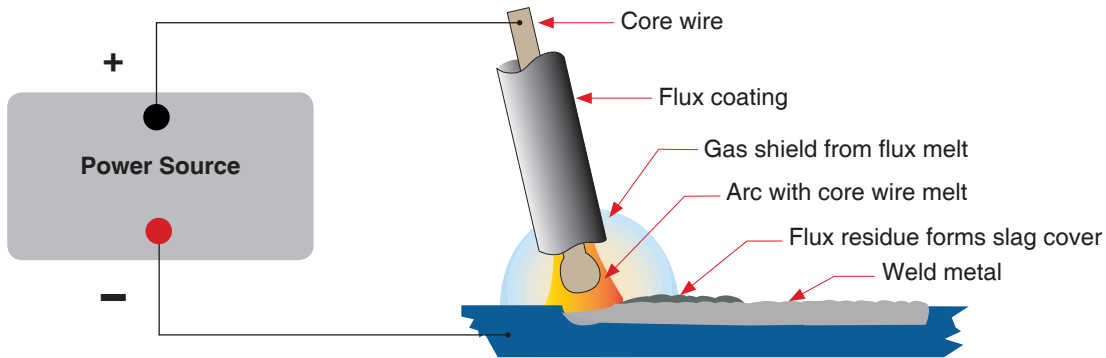

- The arc is initiated by momentarily touching the electrode to the base metal.
- The heat of the arc melts the surface of the base metal to form a molten pool at the end of the electrode.
- The melted electrode metal is transferred across the arc into the molten pool and becomes the deposited weld metal.
- The deposit is covered and protected by a slag which comes from the electrode coating.
- The arc and the immediate area are enveloped by an atmosphere of protective gas

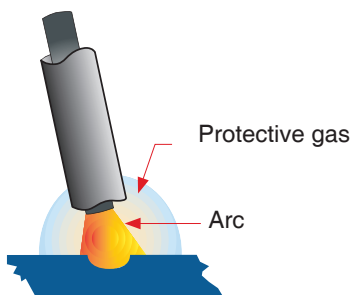

Manual metal arc (stick) electrodes have a solid metal wire core and a flux coating. These electrodes are identified by the wire diameter and by a series of letters and numbers. The letters and numbers identify the metal alloy and the intended use of the electrode.

The **Metal Wire Core** works as conductor of the current that maintains the arc. The core wire melts and is deposited into the welding pool.

The covering on a shielded metal arc welding electrode is called **Flux**. The flux on the electrode performs many different functions.

These include:

- producing a protective gas around the weld area
- providing fluxing elements and deoxidizers
- creating a protective slag coating over the weld as it cools
- establishing arc characteristics
- adding alloying elements.

Covered electrodes serve many purposes in addition to adding filler metal to the molten pool. These additional functions are provided mainly by the covering on the electrode.

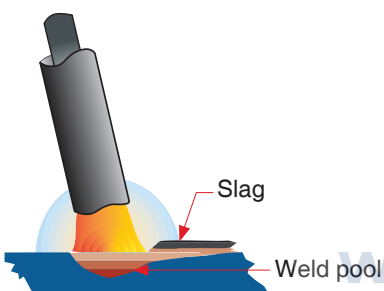

# MMA (Stick) Welding Fundamentals

## Electrode Selection

As a general rule, the selection of an electrode is straight forward, in that it is only a matter of selecting an electrode of similar composition to the parent metal. However, for some metals there is a choice of several electrodes, each of which has particular properties to suit specific classes of work. It is recommended to consult your welding supplier for the correct selection of electrode.

## Electrode Size

Average Thickness of Material	Maximum Recommended Electrode Diameter
1.0 - 2.0mm	2.5mm
2.0 - 5.0mm	3.2mm
5.0 - 8.0mm	4.0mm
8.0 - > mm	5.0mm

The size of the electrode generally depends on the thickness of the section being welded, and the thicker the section the larger the electrode required. The table gives the maximum size of electrodes that may be used for various thicknesses of section based on using a general purpose type 6013 electrode.

## Welding Current (Amperage)

Electrode Size ø mm	Current Range (Amps)
2.5mm	60 - 95
3.2mm	100 - 130
4.0mm	130 - 165
5.0mm	165 - 260

Correct current selection for a particular job is an important factor in arc welding. With the current set too low, difficulty is experienced in striking and maintaining a stable arc. The electrode tends to stick to the work, penetration is poor and beads with a distinct rounded profile will be deposited. Too high current is accompanied by overheating of the electrode resulting in undercut and burning through of the base metal and producing

excessive spatter. Normal current for a particular job may be considered as the maximum, which can be used without burning through the work, overheating the electrode or producing a rough spattered surface. The table shows current ranges generally recommended for a general purpose type 6013 electrode.

## Arc Length

To strike the arc, the electrode should be gently scraped on the work until the arc is established. There is a simple rule for the proper arc length; it should be the shortest arc that gives a good surface to the weld. An arc too long reduces penetration, produces spatter and gives a rough surface finish to the weld. An excessively short arc will cause sticking of the electrode and result in poor quality welds. General rule of thumb for down hand welding is to have an arc length no greater than the diameter of the core wire.

## Electrode Angle

The angle that the electrode makes with the work is important to ensure a smooth, even transfer of metal. When welding in down hand, fillet, horizontal or overhead the angle of the electrode is generally between 5 and 15 degrees towards the direction of travel. When vertical up welding the angle of the electrode should be between 80 and 90 degrees to the work piece.

## Travel Speed

The electrode should be moved along in the direction of the joint being welded at a speed that will give the size of run required. At the same time, the electrode is fed downwards to keep the correct arc length at all times. Excessive travel speeds lead to poor fusion, lack of penetration etc, while too slow a rate of travel will frequently lead to arc instability, slag inclusions and poor mechanical properties.

## Material and Joint Preparation

The material to be welded should be clean and free of any moisture, paint, oil, grease, mill scale, rust or any other material that will hinder the arc and contaminate the weld material. Joint preparation will depend on the method used include sawing, punching, shearing, machining, flame cutting and others. In all cases edges should be clean and free of any contaminants. The type of joint will be determined by the chosen application.



Ph: 09 274 1246

info@weldingtechnology.co.nz

www.weldingtechnology.co.nz

# Installation & Set Up for DC TIG Welding with ARCLITE 140 / 160

- (1) Switch on the machine.
- (2) Insert the power cable plug of the Tig torch into the **Negative** socket on the front of the machine and tighten it.
- (3) Insert the earth cable plug into the **Positive** socket on the front of the machine and tighten it.
- (4) Connect the gas line of the Tig torch to regulator and connect the regulator to the gas cylinder.



(5) Assemble front end parts of the TIG torch, fitting a sharpened tungsten suitable for DC welding.



(15) Carefully open the valve of the gas cylinder, set the flow to 6-10 l/min



(16) Set the welding current using the amperage control dial

**WELDING TECHNOLOGY**  
SUPPLIERS OF WELDING AND ENGINEERING EQUIPMENT



Ph: 09 274 1246  
info@weldingtechnology.co.nz  
www.weldingtechnology.co.nz

## SCRATCH ARC DC TIG Operation with ARCLITE 140 / 160

Scratch Arc ignition allows the arc to be started in DC Tig by lightly scratching the tungsten in a backward motion against the work piece, (similar to striking a match) lift the tungsten slightly from the work piece to establish and hold an arc.

- (5) Make sure the front end parts of the tig torch are correctly assembled, use the correct size and type of tungsten electrode for the job, the tungsten electrode requires a sharpened point for DC welding.
- (6) Turn on the Gas Valve located on the tig torch handle.
- (7) Lay the outside edge of the Gas Cup on the work piece with the Tungsten Electrode 1- 2mm from the work piece.
- (8) Now drag the torch backwards lightly touch the tungsten to the work piece as you drag the torch.
- (9) The arc will strike, as it does lift the tungsten slightly from the work piece to maintain the arc.



(5) Assemble front end parts of the TIG torch, fitting a sharpened tungsten suitable for DC welding.

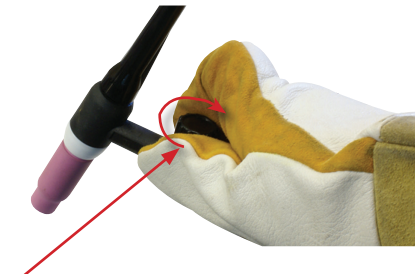

(6) Turn on the Gas Valve



(7) Lay the outside edge of the Gas Cup on the work piece with the Tungsten Electrode 1- 2mm from the work piece.

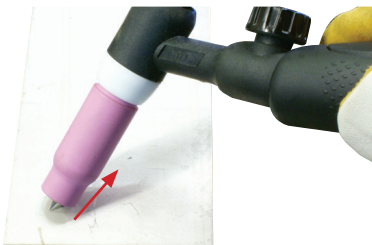

(8) Now drag the torch backwards lightly touch the tungsten to the work piece at the same time.

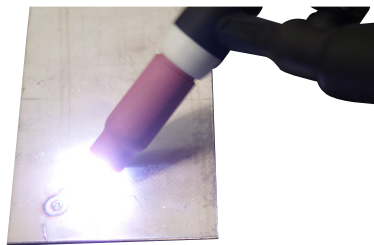

(9) The arc will strike and lift the tungsten slightly from the work piece to maintain the arc.

**IMPORTANT! - We strongly recommend that you check for gas leakage prior to operation of your machine. We recommend that you close the cylinder valve when the machine is not in use.**

**WELDING TECHNOLOGY**  
SUPPLIERS OF WELDING AND ENGINEERING EQUIPMENT

Esseti NZ Ltd, authorised representatives or agents of Esseti NZ Ltd will not be liable or responsible for the loss of any gas.



Ph: 09 274 1240  
www.weldingtechnology.co.nz  
www.weldingtechnology.co.nz

# DC TIG Welding

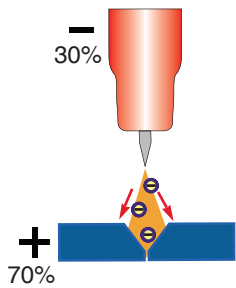

The DC power source uses what is known as DC (direct current) in which the main electrical component known as electrons flow in only one direction from the negative pole (terminal) to the positive pole (terminal). In the DC electrical circuit there is an electrical principle at work which should always be taken into account when using any DC circuit. With a DC circuit 70% of the energy (heat) is always on the positive side. This needs to be understood because it determines what terminal the TIG torch will be connected to (this rule applies to all the other forms of DC welding as well ).

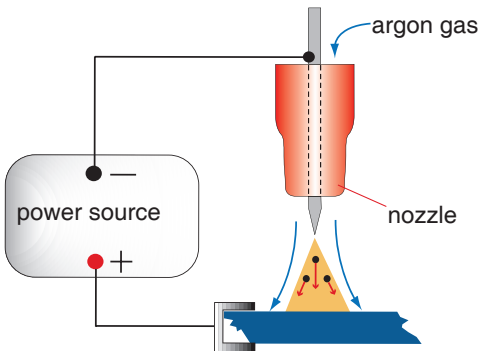

DC TIG welding is a process in which an arc is struck between a TUNGSTEN electrode and the metal work piece. The weld area is shielded by an inert gas flow to prevent contamination of the tungsten, molten pool and weld area.

When the TIG arc is struck the inert gas is ionized and superheated changing it's molecular structure which converts it into a plasma stream. This plasma stream flowing between the tungsten and the work piece is the TIG arc and can be as hot as 19,000°C. It is a very pure and concentrated arc which provides the controlled melting of most metals into a weld pool. TIG welding offers the user the greatest amount of flexibility to weld the widest range of material and thickness and types. DC TIG welding is also the cleanest weld with no sparks or spatter.

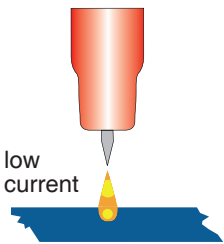

The intensity of the arc is proportional to the current that flows from the tungsten. The welder regulates the welding current to adjust the power of the arc. Typically thin material requires a less powerful arc with less heat to melt the material so less current (amps) is required, thicker material requires a more powerful arc with more heat so more current (amps) are necessary to melt the material.

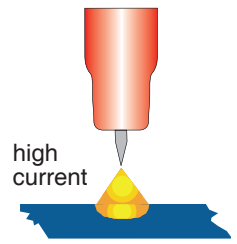

## LIFT ARC IGNITION for TIG (tungsten inert gas) Welding

Lift Arc is a form of arc ignition where the machine has low voltage on the electrode to only a few volts, with a current limit of one or two amps (well below the limit that causes metal to transfer and contamination of the weld or electrode). When the machine detects that the tungsten has left the surface and a spark is present, it immediately (within microseconds) increases power, converting the spark to a full arc. It is a simple, safe lower cost alternative arc ignition process to HF (high frequency) and a superior arc start process to scratch start.

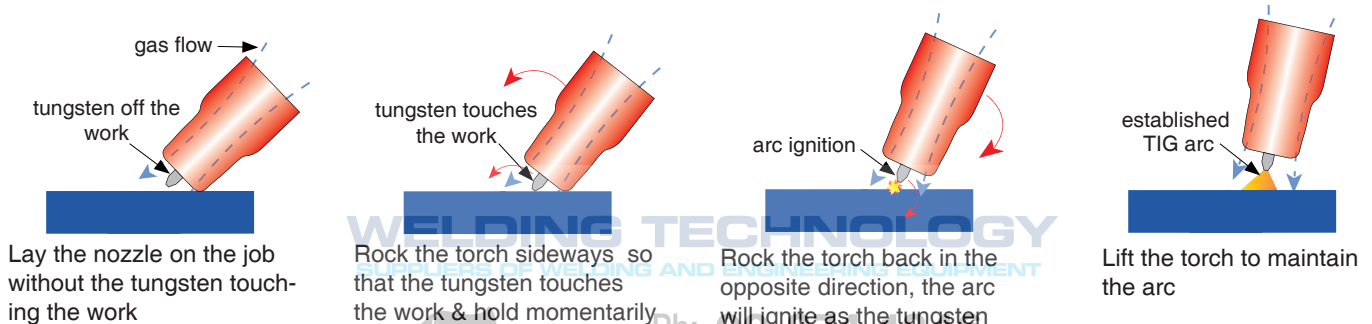

# TIG Welding Fusion Technique

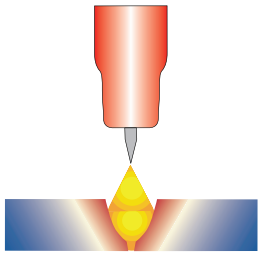

Manual TIG welding is often considered the most difficult of all the welding processes. Because the welder must maintain a short arc length, great care and skill are required to prevent contact between the electrode and the workpiece. Similar to Oxygen Acetylene torch welding, Tig welding normally requires two hands and in most instances requires the welder to manually feed a filler wire into the weld pool with one hand while manipulating the welding torch in the other. However, some welds combining thin materials can be accomplished without filler metal like edge, corner, and butt joints.

This is known as Fusion welding where the edges of the metal pieces are melted together using only the heat and arc force generated by the TIG arc. Once the arc is started the torch tungsten is held in place until a weld pool is created, a circular movement of the tungsten will assist in creating a weld pool of the desired size. Once the weld pool is established tilt the torch at about a 75° angle and move smoothly and evenly along the joint while fusing the materials together.

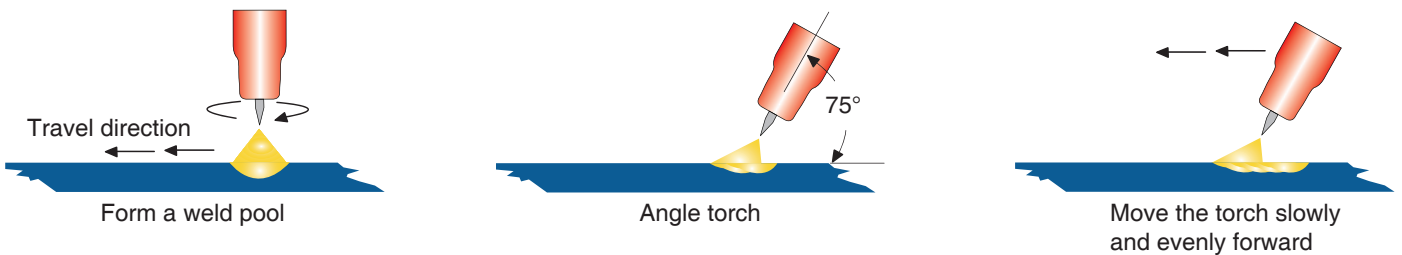

# TIG Welding with Filler Wire Technique

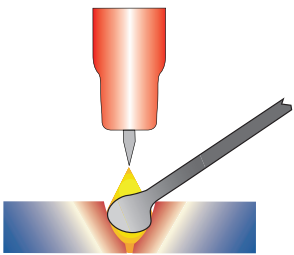

It is necessary in many situations with TIG welding to add a filler wire into the weld pool to build up weld reinforcement and create a strong weld. Once the arc is started the torch tungsten is held in place until a weld pool is created, a circular movement of the tungsten will assist in creating a weld pool of the desired size. Once the weld pool is established tilt the torch at about a 75° angle and move smoothly and evenly along the joint. The filler metal is introduced to the leading edge of the weld pool. The filler wire is usually held at about a 15° angle and fed into the leading edge of the molten pool, the arc will melt the filler wire into the weld pool as the torch is moved forward.

Also a dabbing technique can be used to control the amount of filler wire added, the wire is fed into the molten pool and retracted in a repeating sequence as the torch is moved slowly and evenly forward. It is important during the welding to keep the molten end of the filler wire inside the gas shield as this protects the end of the wire from being oxidised and contaminating the weld pool.

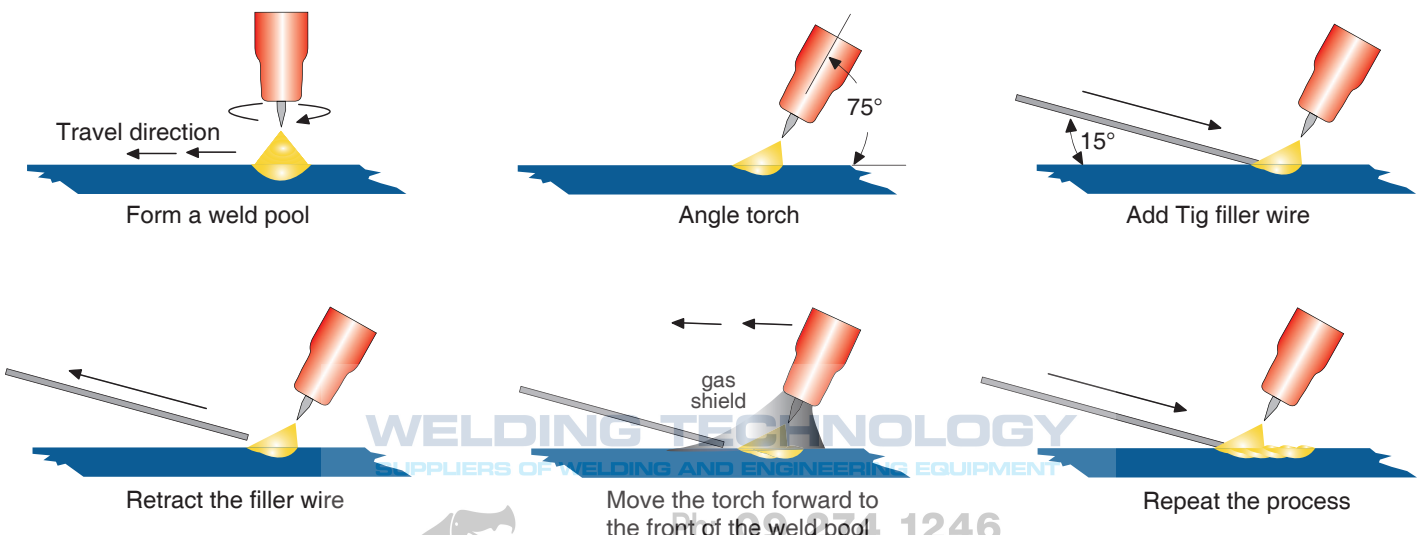

WELDING TECHNOLOGY  
SUPPLIERS OF WELDING AND ENGINEERING EQUIPMENT



1246  
info@weldingtechnology.co.nz  
www.weldingtechnology.co.nz

## Tungsten Electrodes

Tungsten is a rare metallic element used for manufacturing TIG welding electrodes. The TIG process relies on tungsten's hardness and high-temperature resistance to carry the welding current to the arc. Tungsten has the highest melting point of any metal, 3,410 degrees Celsius. Tungsten electrodes are nonconsumable and come in a variety of sizes, they are made from pure tungsten or an alloy of tungsten and other rare earth elements. Choosing the correct tungsten depends on the material being welded, amps required and whether you are using AC or DC welding current. Tungsten electrodes are colour-coded at the end for easy identification. Below are the most commonly used tungsten electrodes found in the New Zealand and Australian market.

### Thoriated

Thoriated tungsten electrodes (AWS classification EWTh-2) contain a minimum of 97.30 percent tungsten and 1.70 to 2.20 percent thorium and are called 2 percent thoriated. They are the most commonly used electrodes today and are preferred for their longevity and ease of use. Thorium however is a low-level radioactive hazard and many users have switched to other alternatives. Regarding the radioactivity, thorium is an alpha emitter but when it is enclosed in a tungsten matrix the risks are negligible. Thoriated tungsten should not get in contact with open cuts or wounds. The more significant danger to welders can occur when thorium oxide gets into the lungs. This can happen from the exposure to vapours during welding or from ingestion of material/dust in the grinding of the tungsten. Follow the manufacturer's warnings, instructions, and the Material Safety Data Sheet (MSDS) for its use.

### E3 (Color Code: Purple)

E3 tungsten electrodes (AWS classification EWG) contain a minimum of 98% percent tungsten and up to 1.5 percent Lanthanum and small percentages of Zirconium and Yttrium they are called E3 Tungsten. E3 Tungsten Electrodes provide conductivity similar to that of thoriated electrodes. Typically, this means that E3 Tungsten Electrodes are exchangeable with thoriated electrodes without requiring significant welding process changes. E3 deliver superior arc starting, electrode lifetime, and overall cost-effectiveness. When E3 Tungsten Electrodes are compared with 2% thoriated tungsten, E3 requires fewer re-grinds and provides a longer overall lifetime. Tests have shown that ignition delay with E3 Tungsten Electrodes actually improves over time, while 2% thoriated tungsten starts to deteriorate after only 25 starts. At equivalent energy output, E3 Tungsten Electrodes run cooler than 2% thoriated tungsten, thereby extending overall tip lifetime. E3 Tungsten Electrodes work well on AC or DC. They can be used DC electrode positive or negative with a pointed end, or balled for use with AC power sources.

### Ceriated (Color Code: Orange)

Ceriated tungsten electrodes (AWS classification EWCe-2) contain a minimum of 97.30 percent tungsten and 1.80 to 2.20 percent cerium and are referred to as 2 percent ceriated. Ceriated tungstens perform best in DC welding at low current settings. They have excellent arc starts at low amperages and become popular in such applications as orbital tube welding, thin sheet metal work. They are best used to weld carbon steel, stainless steel, nickel alloys, and titanium, and in some cases it can replace 2 percent thoriated electrodes. Ceriated tungsten is best suited for lower amperages it should last longer than Thoriated tungsten higher amperage applications are best left to Thoriated or Lanthanated tungsten.

### Lanthanated (Color Code: Gold)

Lanthanated tungsten electrodes (AWS classification EWL-1.5) contain a minimum of 97.80 percent tungsten and 1.30 percent to 1.70 percent lanthanum, and are known as 1.5 percent lanthanated. These electrodes have excellent arc starting, a low burn off rate, good arc stability, and excellent re-ignition characteristics. Lanthanated tungstens also share the conductivity characteristics of 2 percent thoriated tungsten. Lanthanated tungsten electrodes are ideal if you want to optimise your welding capabilities. They work well on AC or DC electrode negative with a pointed end, or they can be balled for use with AC sine wave power sources. Lanthanated tungsten maintains a sharpened point well, which is an advantage for welding steel and stainless steel on DC or AC from square wave power sources.

### Zirconiated (Color Code: White)

Zirconiated tungsten electrodes (AWS classification EWZr-1) contain a minimum of 99.10 percent tungsten and 0.15 to 0.40 percent zirconium. Most commonly used for AC welding Zirconiated tungsten produces a very stable arc and is resistant to tungsten spitting. It is ideal for AC welding because it retains a balled tip and has a high resistance to contamination. Its current-carrying capacity is equal to or greater than that of thoriated tungsten. Zirconiated tungsten is not recommended for DC welding.

## Tungsten Electrodes Rating for Welding Currents

Tungsten Diameter mm	DC Current Amps Torch Negative 2% Thoriated	AC Current Amps Un-Balanced Wave 0.8% Zirconiated	AC Current Amps Balanced Wave 0.8% Zirconiated
1.0mm	15 - 80	15 - 80	20 - 60
1.6mm	70 - 150	70 - 150	60 - 120
2.4mm	150 - 250	140 - 235	100 - 180
3.2mm	250 - 400	225 - 325	160 - 250
4.0mm	400 - 500	320 - 400	200 - 320

**WELDING TECHNOLOGY**  
SUPPLIERS OF WELDING AND ENGINEERING EQUIPMENT

Ph: 09 274 1246

info@weldingtechnology.co.nz

www.weldingtechnology.co.nz



# Tungsten Preparation

Always use **DIAMOND** wheels when grinding and cutting. While tungsten is a very hard material, the surface of a diamond wheel is harder, and this makes for smooth grinding. Grinding without diamond wheels, such as aluminium oxide wheels, can lead to jagged edges, imperfections, or poor surface finishes not visible to the eye that will contribute to weld inconsistency and weld defects.

Always ensure to grind the tungsten in a longitudinal direction on the grinding wheel. Tungsten electrodes are manufactured with the molecular structure of the grain running lengthwise and thus grinding crosswise is “grinding against the grain.” If electrodes are ground crosswise, the electrons have to jump across the grinding marks and the arc can start before the tip and wander. Grinding longitudinally with the grain, the electrons flow steadily and easily to the end of the tungsten tip. The arc starts straight and remains narrow, concentrated, and stable.

grind longitudinal on the grinding wheel

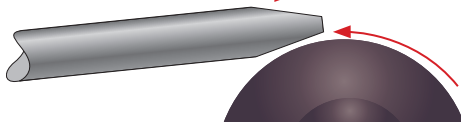

don't grind across the grinding wheel

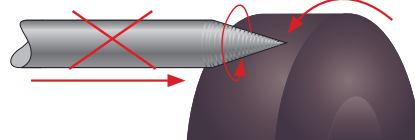

## Electrode Tip/Flat

The shape of the tungsten electrode tip is an important process variable in precision arc welding. A good selection of tip/flat size will balance the need for several advantages. The bigger the flat, the more likely arc wander will occur and the more difficult it will be to arc start. However, increasing the flat to the maximum level that still allows arc start and eliminates arc wander will improve the weld penetration and increase the electrode life. Some welders still grind electrodes to a sharp point, which makes arc starting easier. However, they risk decreased welding performance from melting at the tip and the possibility of the point falling off into the weld pool.

2.5 times tungsten diameter

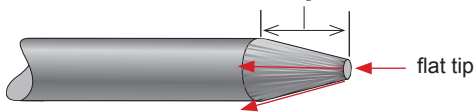

## Electrode Included Angle/Taper - DC Welding

Tungsten electrodes for DC welding should be ground longitudinally and concentrically with diamond wheels to a specific included angle in conjunction with the tip/flat preparation. Different angles produce different arc shapes and offer different weld penetration capabilities. In general, blunter electrodes that have a larger included angle provide the following benefits:

- Last Longer
- Have better weld penetration
- Have a narrower arc shape
- Can handle more amperage without eroding.

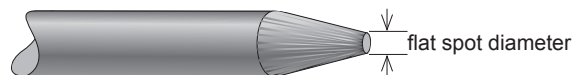

Sharper electrodes with smaller included angle provide:

- Offer less arc weld
- Have a wider arc
- Have a more consistent arc



The included angle determines weld bead shape and size. Generally, as the included angle increases, penetration increases and bead width decreases.

Tungsten Diameter	Diameter at the Tip - mm	Constant Included Angle - Degrees	Current Range Amps	Current Range Pulsed Amps
1.0mm	.250	20	05 - 30	05 - 60
1.6mm	.500	25	08 - 50	05 - 100
1.6mm	.800	30	10 - 70	10 - 140
2.4mm	.800	35	12 - 90	12 - 180
2.4mm	1.100	45	15 - 150	15 - 250
3.2mm	1.100	60	20 - 200	20 - 300
3.2mm	1.500	90	25 - 250	25 - 350

**WELDING TECHNOLOGY**  
SUPPLIERS OF WELDING AND ENGINEERING EQUIPMENT

Ph 09 274 1246

info@weldingtechnology.co.nz  
www.weldingtechnology.co.nz

# TIG WELDING TORCHES

## XA17V Suregrip TIG Torch 150 Amp - Valved Head

Air Cooled 150 Amp - Available in 4m, 8m Lengths



## XA17V TIG TORCH

### Suregrip Series

150AMP AIR COOLED

Gas Valve Torch Head

Rating: 150A DC, 105AAC @35% duty cycle.

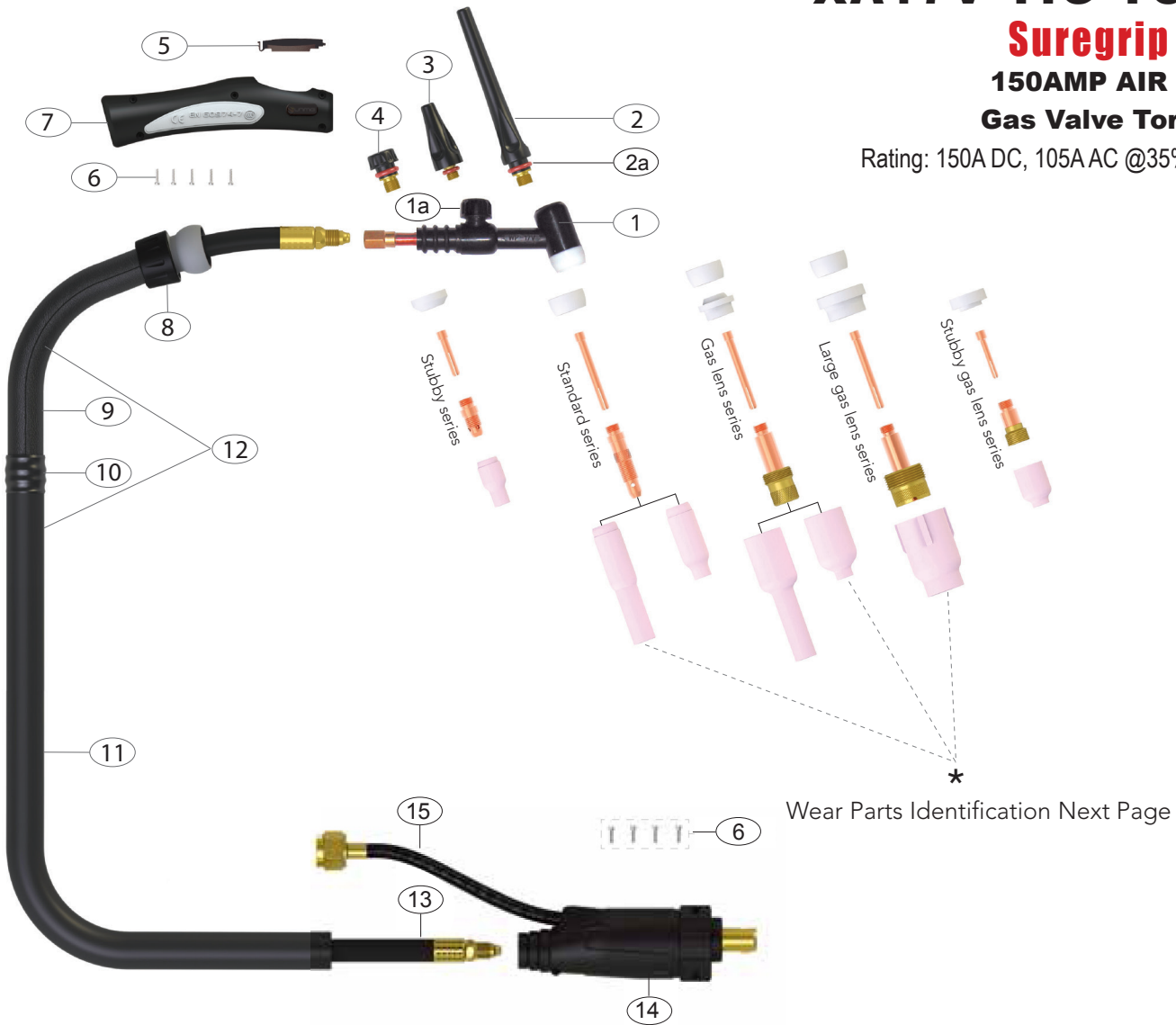

Wear Parts Identification Next Page

Torch Model		Part Number	
Description		4m	8m
XA17V Tig Torch 16-25 Twistlok End, 2m Gas Hose		XA17V-12NBD25	XA17V-25NBD25
XA17V Tig Torch 35-50 Twistlok End, 2m Gas Hose		XA17V-12NBD50	XA17V-25NBD50
XA17VFX Flexi Tig Torch 16-25 Twistlok End, 2m Gas Hose		XA17VFX-12NBD25	XA17VFX-25NBD25
XA17VFX Flexi Tig Torch 35-50 Twistlok End, 2m Gas Hose		XA17VFX-12NBD50	XA17VFX-25NBD50

Spare Parts	
Part Number	Description
1	XA17V Torch Body with Valve
	XA17VFX Torch Body Flexible with Valve
1a	VS-2 Valve Stem
2	57Y02 Back Cap Long
2a	98W18 Back Cap O Ring
3	P300M Back Cap Medium
4	57Y04 Back Cap Short
5	ERBS Blank Switch Cover
6	ERSP1 Screw Pack
7	ERH100 Small Ergo Tig Handle
8	ERKJ100 Small Knuckle Joint & Lock Nut
9	ERLC100-08 Leather Cover x 0.8m

Spare Parts	
Part Number	Description
10	ERJK100 Jointing Repair Kit
11	ERNCS-32 Neoprene Cover x 3.2m
	ERNCS-72 Neoprene Cover x 7.2m
12	ERCO100-40 Sheath x 4m c/w Leather Cover
	ERCO100-80 Sheath x 8m c/w Leather Cover
13	U57Y01-APC1 Power Cable 3/8UNF x 4m
	U57Y03-APC1 Power Cable 3/8UNF x 8m
14	UD1025-38 Twistlok Connector 3/8 10-25
	UD3550-38 Twistlok Connector 3/8 35-50
15	WGCP-1V-58 Gas Hose Assembly x 2m



Ph: 09 274 1246  
 info@weldingtechnology.co.nz  
 www.weldingtechnology.co.nz

# TIG WELDING TORCHES

## XA17V Suregrip TIG Torch 150 Amp

Torch Head Parts - Collets, Collet Bodies, Gas Lens, Gaskets, Nozzles



### Standard Front End Parts

**Part #** Description  
18CG Cup Gasket



**Part #** Description  
10N22 Collet 1.0mm  
10N23 Collet 1.6mm  
10N24 Collet 2.4mm  
10N25 Collet 3.2mm



**Part #** Description  
10N30 Collet Body 1.0mm  
10N31 Collet Body 1.6mm  
10N32 Collet Body 2.4mm  
10N28 Collet Body 3.2mm



**Part #** Description  
10N50 Alumina Nozzle Ø 6mm #4  
10N49 Alumina Nozzle Ø 8mm #5  
10N48 Alumina Nozzle Ø 10mm #6  
10N47 Alumina Nozzle Ø 11mm #7  
10N46 Alumina Nozzle Ø 13mm #8  
10N45 Alumina Nozzle Ø 16mm #10  
10N44 Alumina Nozzle Ø 19mm #12



**Part #** Description  
10N49L Long Alumina Nozzle Ø 8mm #5L  
10N48L Long Alumina Nozzle Ø 10mm #6L  
10N47L Long Alumina Nozzle Ø 11mm #7L

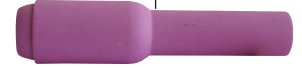

### Gas Lens Front End Parts

**Part #** Description  
18CG Cup Gasket  
54N01 Gas Lens Gasket



**Part #** Description  
10N22 Collet 1.0mm  
10N23 Collet 1.6mm  
10N24 Collet 2.4mm  
10N25 Collet 3.2mm



**Part #** Description  
45V24 Gas Lens Collet Body 1.0mm  
45V25 Gas Lens Collet Body 1.6mm  
45V26 Gas Lens Collet Body 2.4mm  
45V27 Gas Lens Collet Body 3.2mm



**Part #** Description  
54N18 Gas Lens Nozzle Ø 6mm #4  
54N17 Gas Lens Nozzle Ø 8mm #5  
54N16 Gas Lens Nozzle Ø 10mm #6  
54N15 Gas Lens Nozzle Ø 11mm #7  
54N14 Gas Lens Nozzle Ø 12mm #8  
54N19 Gas Lens Nozzle Ø 16mm #11



**Part #** Description  
54N17L Long Gas Lens Nozzle Ø 8mm #5L  
54N16L Long Gas Lens Nozzle Ø 10mm #6L  
54N15L Long Gas Lens Nozzle Ø 11mm #7L



### Large Gas Lens Front End Parts

**Part #** Description  
18CG Gas Lens Gasket  
54N63 Large Lens Gasket



**Part #** Description  
10N22 Collet 1.0mm  
10N23 Collet 1.6mm  
10N24 Collet 2.4mm  
10N25 Collet 3.2mm



**Part #** Description  
45V0204 Large Gas Lens Body 1.0mm  
45V116 Large Gas Lens Body 1.6mm  
45V64 Large Gas Lens Body 2.4mm  
995795 Large Gas Lens Body 3.2mm

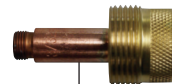

**Part #** Description  
57N75 Large Gas Lens Nozzle Ø 10mm #6  
57N74 Large Gas Lens Nozzle Ø 12mm #8  
53N88 Large Gas Lens Nozzle Ø 16mm #10  
53N87 Large Gas Lens Nozzle Ø 19mm #12



### Stubby Front End Parts

**Part #** Description  
18CG20 Stubby Cup Gasket



**Part #** Description  
10N22S Stubby Collet 1.0mm  
10N23S Stubby Collet 1.6mm  
10N24S Stubby Collet 2.4mm  
10N25S Stubby Collet 3.2mm



**Part #** Description  
17CB20 Stubby Collet Body  
Fits 1.0 - 3.2mm

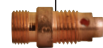

**Part #** Description  
13N08 Alumina Nozzle Ø 6mm #4  
13N09 Alumina Nozzle Ø 8mm #5  
13N10 Alumina Nozzle Ø 10mm #6  
13N11 Alumina Nozzle Ø 11mm #7  
13N12 Alumina Nozzle Ø 13mm #8  
13N13 Alumina Nozzle Ø 16mm #10



**Part #** Description  
796F70 Long Alumina Nozzle Ø 4mm #3  
796F71 Long Alumina Nozzle Ø 6mm #4  
796F72 Long Alumina Nozzle Ø 8mm #5  
796F73 Long Alumina Nozzle Ø 10mm #6



### Stubby Gas Lens Front End Parts

**Part #** Description  
80300236 Gas Lens Gasket



**Part #** Description  
10N23S Stubby Collet 1.6mm  
10N24S Stubby Collet 2.4mm  
10N25S Stubby Collet 3.2mm



**Part #** Description  
USTB45V43 Stubby Gas Lens Body 1.6mm  
USTB45V44 Stubby Gas Lens Body 2.4mm  
USTB45V45 Stubby Gas Lens Body 3.2mm



**Part #** Description  
53N58 Gas Lens Nozzle Ø 6mm #4  
53N59 Gas Lens Nozzle Ø 8mm #5  
53N60 Gas Lens Nozzle Ø 10mm #6  
53N61 Gas Lens Nozzle Ø 11mm #7  
53N61S Gas Lens Nozzle Ø 15mm #8



WELDING TECHNOLOGY



Ph: 09 274 1246  
info@weldingtechnology.co.nz  
www.weldingtechnology.co.nz

# MMA (Stick) WELDING TROUBLE SHOOTING

The following chart addresses some of the common problems of MMA welding. In all cases of equipment malfunction, the manufacturer's recommendations should be strictly adhered to and followed.

<b>1: No arc</b>	
<i>Possible Reason</i>	<i>Suggested Remedy</i>
Incomplete welding circuit	Check earth lead is connected. Check all cable connections.
Wrong mode selected	Check the MMA selector switch is selected
No power supply	Check that the machine is switched on and has a power supply
<b>2: Porosity – small cavities or holes resulting from gas pockets in weld metal.</b>	
<i>Possible Reason</i>	<i>Suggested Remedy</i>
Arc length too long	Shorten the arc length
Work piece dirty, contaminated or moisture	Remove moisture and materials like paint, grease, oil, and dirt, including mill scale from base metal
Damp electrodes	Use only dry electrodes
<b>3: Excessive Spatter</b>	
<i>Possible Reason</i>	<i>Suggested Remedy</i>
Amperage too high	Decrease the amperage or choose a larger electrode
Arc length too long	Shorten the arc length
<b>3: Weld sits on top, lack of fusion</b>	
<i>Possible Reason</i>	<i>Suggested Remedy</i>
Insufficient heat input	Increase the amperage or choose a larger electrode
Work piece dirty, contaminated or moisture	Remove moisture and materials like paint, grease, oil, and dirt, including mill scale from base metal
Poor welding technique	Use the correct welding technique or seek assistance for the correct technique
<b>4: Lack of penetration</b>	
<i>Possible Reason</i>	<i>Suggested Remedy</i>
Insufficient heat input	Increase the amperage or choose a larger electrode
Poor welding technique	Use the correct welding technique or seek assistance for the correct technique
Poor joint preparation	Check the joint design and fit up, make sure the material is not too thick. Seek assistance for the correct joint design and fit up
<b>5: Excessive penetration - burn through</b>	
<i>Possible Reason</i>	<i>Suggested Remedy</i>
Excessive heat input	Reduce the amperage or use a smaller electrode
Incorrect travel speed	Try increasing the weld travel speed
<b>6: Uneven weld appearance</b>	
<i>Possible Reason</i>	<i>Suggested Remedy</i>
Unsteady hand, wavering hand	Use two hands where possible to steady up, practise your technique
<b>7: Distortion – movement of base metal during welding</b>	
<i>Possible Reason</i>	<i>Suggested Remedy</i>
Excessive heat input	Reduce the amperage or use a smaller electrode
Poor welding technique	Use the correct welding technique or seek assistance for the correct technique
Poor joint preparation and or joint design	Check the joint design and fit up, make sure the material is not too thick. Seek assistance for the correct joint design and fit up
<b>7: Electrode welds with different or unusual arc characteristic</b>	
<i>Possible Reason</i>	<i>Suggested Remedy</i>
Incorrect polarity	Change the polarity, check the electrode manufacturer for correct polarity



# TIG WELDING TROUBLE SHOOTING

The following chart addresses some of the common problems of DC TIG welding. In all cases of equipment malfunction, the manufacturer's recommendations should be strictly adhered to and followed.

<b>1: Tungsten burning away quickly</b>	
<i>Possible Reason</i>	<i>Suggested Remedy</i>
Incorrect Gas	Check that pure Argon is being used
No gas	Check the gas cylinder contains gas and is connected and the torch gas valve is open
Inadequate gas flow	Check the gas is connected, check hoses, gas valve and torch are not restricted. Set the gas flow between 10 - 15 l/min flow rate
Back cap not fitted correctly	Make sure the torch back cap is fitted so that the o-ring is inside the torch body
Torch connected to DC +	Connect the torch to the DC- output terminal
Incorrect tungsten being used	Check and change the tungsten type if necessary
Tungsten being oxidised after weld is finished	Keep shielding gas flowing 10–15 seconds after arc stoppage. 1 second for each 10 amps of weld current.
<b>2: Contaminated tungsten</b>	
<i>Possible Reason</i>	<i>Suggested Remedy</i>
Touching tungsten into the weld pool	Keep tungsten from contacting weld puddle. Raise the torch so that the tungsten is off of the work piece 2 - 5mm
Touching the filler wire to the tungsten	Keep the filler wire from touching the tungsten during welding, feed the filler wire into the leading edge of the weld pool in front of the tungsten
Tungsten melting into the weld pool	Check that correct type of tungsten is being used. Too much current for the tungsten size so reduce the amps or change to a larger tungsten
<b>3: Porosity - poor weld appearance and colour</b>	
<i>Possible Reason</i>	<i>Suggested Remedy</i>
Incorrect Gas	Check that pure Argon is being used
Inadequate gas flow / gas leaks	Check the gas is connected, check hoses, gas valve and torch are not restricted. Set the gas flow between 10 - 15 l/min flow rate. Check hoses and fittings for holes, leaks etc.,
Moisture on the base metal	Remove all moisture from base metal before welding
Contaminated base metal	Remove materials like paint, grease, oil, and dirt, including mill scale from base metal
Contaminated filler wire	Remove all grease, oil, or moisture from filler metal.
Incorrect filler wire	Check the filler wire and change if necessary
<b>4: Yellowish residue / smoke on the alumina nozzle &amp; discoloured tungsten</b>	
<i>Possible Reason</i>	<i>Suggested Remedy</i>
Incorrect Gas	Use pure Argon gas
Inadequate gas flow	Set the gas flow between 10 - 15 l/min flow rate
Alumina gas nozzle too small for size of tungsten being used	Increase the size of the alumina gas nozzle
<b>5: Unstable Arc during DC welding</b>	
<i>Possible Reason</i>	<i>Suggested Remedy</i>
Torch connected to DC +	Connect the torch to the DC- output terminal
Contaminated base metal	Remove materials like paint, grease, oil, and dirt, including mill scale from base metal.
Tungsten is contaminated	Remove 10mm of contaminated tungsten and re grind the tungsten
Arc length too long	Lower torch so that the tungsten is off of the work piece 2 - 5mm
<b>7: Arc wanders during DC welding</b>	
<i>Possible Reason</i>	<i>Suggested Remedy</i>
Poor gas flow	Check and set the gas flow between 10 - 15 l/min flow rate
Incorrect arc length	Lower torch so that the tungsten is off of the work piece 2 - 5mm
Tungsten incorrect or in poor condition	Check that correct type of tungsten is being used. Remove 10mm from the weld end of the tungsten and re sharpen the tungsten
Poorly prepared tungsten	Grind marks should run lengthwise with tungsten, not circular. Use proper grinding method and wheel.
Contaminated base metal	Remove contaminating materials like paint, grease, oil, and dirt, including mill scale from base metal.
Contaminated filler wire	Remove all grease, oil, or moisture from filler metal.
Incorrect filler wire	Check the filler wire and change if necessary

## continued- TIG WELDING TROUBLE SHOOTING

<b>8: Arc difficult to start or will not start DC welding</b>	
<i>Possible Reason</i>	<i>Suggested Remedy</i>
Incorrect machine set up	Check machine set up is correct
No gas, incorrect gas flow	Check the gas is connected and cylinder valve open, check hoses, gas valve and torch are not restricted. Set the gas flow between 10 - 15 l/min flow rate
Tungsten is contaminated	Remove 10mm of contaminated tungsten and re grind the tungsten
Incorrect tungsten size and or tungsten being used	Check and change the size and or the tungsten if required
Loose connection	Check all connectors and tighten
Earth clamp not connected to work	Connect the earth clamp directly to the work piece wherever possible

## ATTENTION! - CHECK FOR GAS LEAKS

At initial set up and at regular intervals we recommend to check for gas leakage.

Recommended procedure is as follows:

1. Connect the regulator and gas hose assembly and tighten all connectors and clamps.
2. Slowly open the cylinder valve.
3. Set the flow rate on the regulator to approximately 8-10 l/min.
4. Close the cylinder valve and pay attention to the needle indicator of the contents pressure gauge on the regulator, if the needle drops away towards zero there is a gas leak. Sometimes a gas leak can be slow and to identify it will require leaving the gas pressure in the regulator and line for an extended time period. In this situation it is recommended to open the cylinder valve, set the flow rate to 8-10 l/min, close the cylinder valve and check after a minimum of 15 minutes.
5. If there is a gas loss then check all connectors and clamps for leakage by brushing or spraying with soapy water, bubbles will appear at the leakage point.
6. Tighten clamps or fittings to eliminate gas leakage.

**Important:** We strongly recommend that you check for gas leakage prior to operation of your machine. We recommend that you close the cylinder valve when the machine is not in use.

**WELDING TECHNOLOGY**

Esseti NZ Ltd, authorised representatives or agents of Esseti NZ Ltd will not be liable or responsible for the loss of any gas.



Ph: 09 274 1246

info@weldingtechnology.co.nz

www.weldingtechnology.co.nz

**WELDING TECHNOLOGY**  
SUPPLIERS OF WELDING AND ENGINEERING EQUIPMENT



Ph: 09 274 1246  
info@weldingtechnology.co.nz  
www.weldingtechnology.co.nz

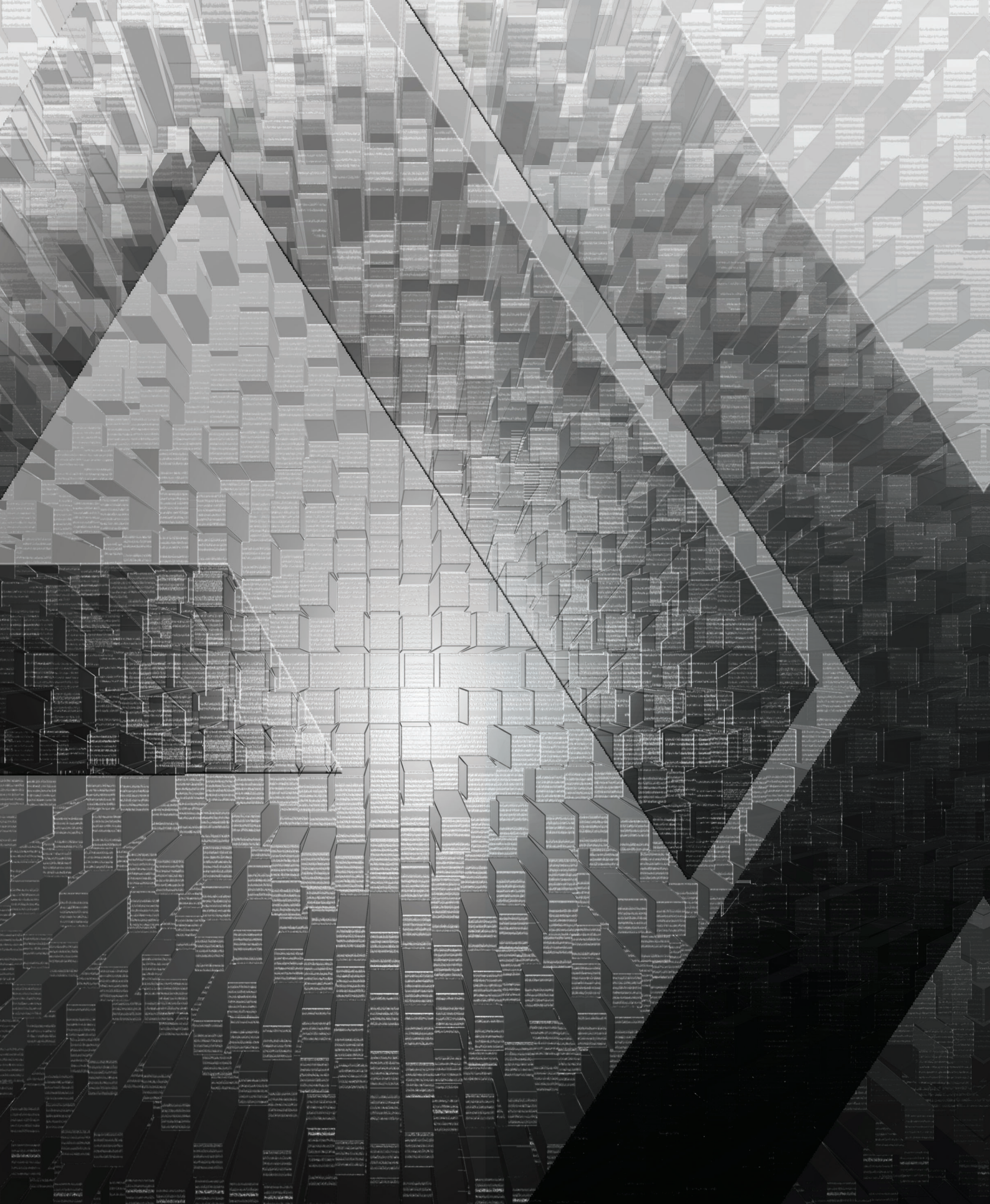

**WELDING TECHNOLOGY**  
SUPPLIERS OF WELDING AND ENGINEERING EQUIPMENT

  
**New Zealand Limited**

Ph: 09 274 1246  
info@weldingtechnology.co.nz  
www.weldingtechnology.co.nz

[www.xcelarc.com](http://www.xcelarc.com)